



UPPSC – Polytechnic Lecturer

Civil Engineering

Uttar Pradesh Public Service Commission (UPPSC)

Volume - 8

Environmental Engineering & Engineering Mechanics



INDEX

| S No. | Chapter Title | Page No. |
|-------|--------------------------------|----------|
| 1 | Water Demand & Resources | 1 |
| 2 | Quality Control of Water | 9 |
| 3 | Water Purification | 19 |
| 4 | Filtration | 36 |
| 5 | Disinfection | 45 |
| 6 | Miscellaneous Water Treatments | 52 |
| 7 | Distribution System | 57 |
| 8 | Design of Sewer System | 67 |
| 9 | Waste Water Characteristics | 78 |
| 10 | Treatment of Sewage | 90 |
| 11 | Sludge Digestion | 106 |
| 12 | Trickling Filters | 112 |
| 13 | Activated Sludge Process | 120 |
| 14 | Oxidation Pond | 129 |
| 15 | Disposal of Sewage Effluent | 131 |
| 16 | Solid Waste Management | 137 |
| 17 | Introduction | 141 |
| 18 | System of Forces | 142 |
| 19 | Friction & Application | 150 |
| 20 | Center of Gravity | 158 |
| 21 | Moment of Inertia | 166 |
| 22 | Kinematics | 173 |
| 23 | Trusses | 184 |

INDEX

| S No. | Chapter Title | Page No. |
|-------|-------------------------------------|----------|
| 24 | Collisions | 195 |
| 25 | Rigid Body Dynamics in Plane Motion | 203 |

1 CHAPTER

Water Demand & Resources

THEORY

1.1 | WATER DEMAND

1.1.1 Domestic Water Demand

The total domestic water consumption usually vary from 50% to 60% of the total water supply to a city. The IS code list down a limit of water consumption between 135 to 225 ltr/capita/day (LPCD). Under ordinary condition (as per IS code) the domestic water demand for a town or a city with full flushing system should be taken as 200 LPCD. Although it can be reduced to 135 LPCD for economical weaker section and LIG colony.

1.1.2 Industrial Water Demand

This quantity varies with number and type of industries present in the city. This consumption under ordinary condition is 50 LPCD. Some industries influence a high water demand like : Paper industry, Textile industries etc.

1.1.3 Institutional and Commercial Water Demand

On an average demand is 20 LPCD. It may be as high as 50 LPCD.

1.1.4 Demand for Public Use

This includes water requirement for parks, gardening washing of roads etc. On this account a normal amount not exceed 5% of consumption may be provided.

1.1.5 Fire Demand

The quantity of water require for fire is not very large. The city upto 50 lakh population hardly amount is 1 LPCD. But this water should be easily available and kept always stored in storage reservoir.

1.1.6 Water Demand for Losses & Theft

This may be as high as 15% of total demand.

1.2 | FACTORS AFFECTING WATER DEMAND

- | | |
|--|---|
| (a) Size of city | (b) Climate condition |
| (c) Industrial and commercial activities | (d) Habits of people |
| (e) Quality of water supply | (f) Pressure in the distribution system. |
| (g) Development of sewage facility. | (h) Cost of water and method of charging. |

1.3 | POPULATION FORECASTING METHODS

Methods are based on laws of probability and growth curve. Following are population forecasting methods :

- | | |
|---|--|
| (a) Arithmetic increase method | (b) Geometric increase method |
| (c) Incremental increase method | (d) Decreasing rate of growth method |
| (e) Simple graphical method | (f) Comparative graphical method |
| (g) Master plan method or zoning method | (h) The ratio method or apportionment method |
| (i) The logistic curve method | |

Methods are Discussed Below:

(a) Arithmetic Increase Method

This method assumes that the population increases at a constant rate :

$$\frac{dP}{dt} = \text{constnat}$$

Forecasted population (P_n) after 'n' decades

$$P_n = P_0 + n\bar{x}$$

where,

P_0 = Population at last known census.

\bar{x} = Average (Arithmetic mean) of population increase in last decades.

n = No. of decades between last census and future.

(b) Geometric Increase Method

It is also known as 'uniform increase method'.

Forecasted population,

$$P_n = P_0 \left(1 + \frac{r}{100}\right)^n$$

where,

P_0 = Population at last known census.

r = Growth rate (%)

$$r = \frac{\text{Increase in population}}{\text{Orginal population}} \times 100 \text{ for each decade.}$$

Knowing as $r_1, r_2, r_3, r_4 \dots \dots \dots r_n$ for each decade.

The average value of r can be found by

(i) Arithmetic average method

$$r = \frac{r_1 + r_2 + r_3 + \dots \dots \dots r_n}{n}$$

(ii) Geometric average method

$$r = (r_1 \times r_2 \times r_3 \dots \dots \dots \times r_n)^{\frac{1}{n}}$$

Note: Engineers adopt arithmetic average method since it gives more value than the geometric avg. Method. However GOI manual on water supply recommends 'Geometric mean method'.

(iii) Incremental increase method:

Rate of growth is not assumed constant.

Population

$$P_n = P_0 + n\bar{x} + \frac{n(n+1)}{2}\bar{y}$$

where,

P_0, n, \bar{x} are as usual.

\bar{y} = Average of Incremental increase of the known decades.

Note: (i) Geometric mean method suitable for younger cities expanding of faster rate.

(ii) Incremental increase method suitable for both old and new cities.

Example: The population of 5 decades from 1930 to 1970 are given below in table. Find out the population after '3' decades beyond the last known decade, by using

(i) Arithmetic mean method (ii) Geometric mean method (iii) incremental increase method

| Year | 1930 | 1940 | 1950 | 1960 | 1970 |
|------------|-------|-------|-------|-------|-------|
| Population | 25000 | 28000 | 34000 | 42000 | 47000 |

Solution:

| Col (1) | Col (2) | Col (3) | Col (4) | Col (5) |
|---------|------------|------------------------|--|----------------------|
| Year | Population | Increase in population | Growth rate (r) % | Incremental increase |
| 1930 | 25000 | | | |
| | | 3000 | $\frac{3000}{25000} \times 100 = 12$ | |
| 1940 | 28000 | | | 6000-3000 = 3000 |
| | | 6000 | $\frac{6000}{28000} \times 100 = 21.4$ | |
| 1950 | 34000 | | | 8000-6000 = 2000 |
| | | 8000 | $\frac{8000}{34000} \times 100 = 23.5$ | |
| 1960 | 42000 | | | 5000-8000 = -3000 |
| | | 5000 | $\frac{5000}{42000} \times 100 = 11.9$ | |
| 1970 | 47000 | | | |
| Total | | $\Sigma = 22000$ | | $\Sigma = 2000$ |

(i) Arithmetic mean method:

$$\bar{x} = \frac{\sum \text{col}(3)}{4} = \frac{22000}{4} = 5500$$

$$P_{2000} = P_{1970} + n\bar{x} \\ = 47000 + 3 \times 5500 = \mathbf{63500}$$

Ans.

(ii) Geometric mean method :

(a)
$$r = \frac{r_1 + r_2 + r_3 + r_4}{4} = \frac{12 + 21.4 + 23.5 + 11.9}{4} = 17.2\%$$

$$P_{2000} = P_{1970} \left(1 + \frac{r}{100}\right)^n$$

$$\begin{aligned}
 (b) \quad r &= (r_1 r_2 r_3 r_4)^{1/4} \\
 &= (12 \times 21.4 \times 23.5 \times 11.9)^{1/4} \\
 &= 16.37\%
 \end{aligned}$$

So,

$$\begin{aligned}
 P_{2000} &= 47000 \left(1 + \frac{16.37}{100}\right)^3 \\
 &= 74066.62 \approx 74067
 \end{aligned}$$

(iii) Incremental Increase method :

$$\begin{aligned}
 \bar{y} &= \frac{\sum \text{col}(s)}{3} = \frac{2000}{3} = 666.67 \\
 P_{2000} &= P_{1970} + n\bar{x} + \frac{n(n+1)}{2}\bar{y} \\
 &= 47000 + 3 \times 5500 + \frac{3(3+1)}{2} \left(\frac{2000}{3}\right) \\
 &= 67500
 \end{aligned}$$

Ans.

1.4 | WATER RESOURCES

Mainly there are two types of water resources:

1. Surface water resources
2. Ground water resources

1. Surface water resources

- ❖ It consist river, lake, water fall etc.
- ❖ Among all the surface water resources rivers are main.
- ❖ The source of water in river is either rain or melting of ice.

2. Ground water resources

- ❖ The main ground water resources are well and tube-well.
- ❖ The possibility of ground water occurrence depends upon (a) Porosity (b) Permeability
 - (a) *Porosity* : Indicates voids in which water will be accumulated.
 - (b) *Permeability* : It represent ability to pass water to itself. Only if permeability is large enough than only water can be taken out from the pores.

1.5 | DARCY'S LAW

As per Darcy the velocity of flow in soil is directly perposonal to hydraulic gradient.

$$\begin{aligned}
 \Rightarrow \quad & V \propto i \\
 \Rightarrow \quad & V = K i \\
 \Rightarrow \quad & Q = KiA
 \end{aligned}$$

Where,

Q = Discharge rate

i = Hydraulic gradient

A = Area of flow

K = Permeability of soil

⇒ In general

$$A = \pi d h$$

But, Area available for flow of the water is only void present in soil mass.

So,

$$A_{\text{actual}} = \eta A$$

where,

η = Porosity

⇒ For the continuity equation,

$$VA = V_{\text{act}} A_{\text{act}}$$

$$V_{\text{act}} = V \left(\frac{A}{A_{\text{act}}} \right)$$

⇒

$$V_{\text{act}} = V_{\text{seepage}} = \frac{V}{\eta}$$

Co-efficient of permeability depends upon pores medium as well as fluid properties.

Co-efficient of permeability is given as

$$K = \frac{Cd^2g}{v}$$

where,

C = shape factor

v = kinematic viscosity of fluid

g = gravity acceleration

d = main or effective size of particle.

The component of permeability which represents only the properties of pores medium is called Intrinsic permeability / Absolute permeability. Given as

$$K_0 = Cd^2$$

$$K_0 = \frac{Kv}{2}$$

$$K_0 = \frac{K\mu}{r}$$

The unit of Intrinsic permeability is “m²” Or “Darcy”

$$1 \text{ darcy} = 9.87 \times 10^{-13} \text{ m}^2$$

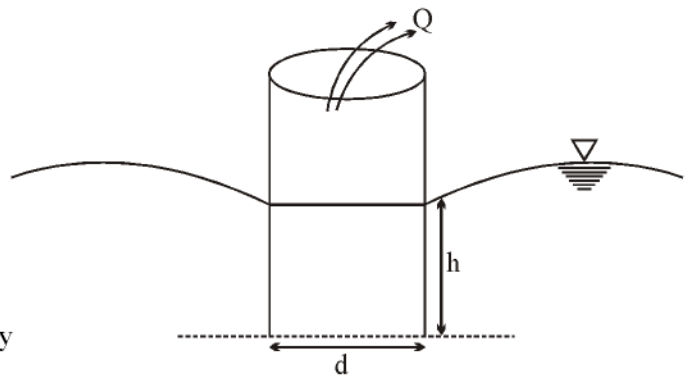

1.6 | TYPE OF GROUND LAYERS

On the basis of porosity and permeability the following types of layers are given.

1. *Aquifuse* : Neither pores nor permeable. *Example* : Granite.
2. *Aquitard* : Its permeability is less. It does not yield ground water freely, but seepage is possible through it.
Example : sandy clay.
3. *Aquiclude* : Highly pores but not permeable. *Example* : Clayey soil.
4. *Aquifer* : High pores and enough permeable. *Example*: sand deposits

1.7 | GROUND WATER YEILD

All water in the pores cannot be drained out under gravity. Some water can be retain due to molecular attraction. It is called “Pellicular water”

$$\text{Specific yield} = \frac{\text{Volume of water drain out under gravity}}{\text{Total volume of soil being drain out}}$$

$$\text{Specific retention} = \frac{\text{Volume of water retain}}{\text{Total volume of soil being drain out}}$$

$$\boxed{\text{Specific yield} + \text{Specific retention} = \eta}$$

Smaller the particle size larger will be retention.

1.8 | SPECIFIC CAPACITY

It is a rate of flow from well per unit drawdown. *Various form of under ground source and there exploration:*

1. Infiltration Gallery

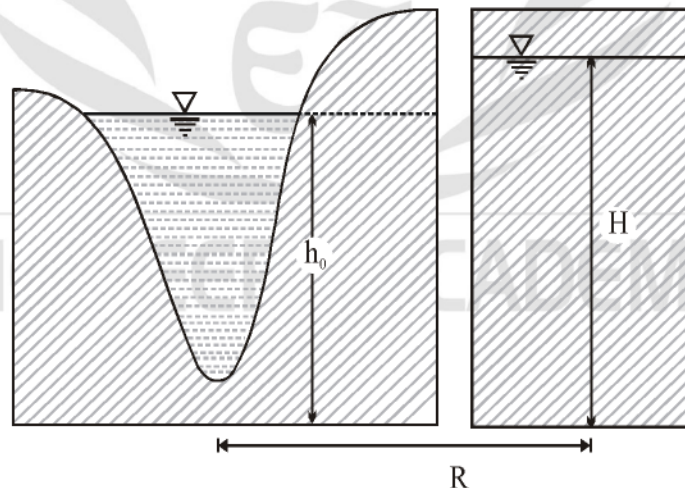

infiltration gallery

$$\text{Discharge } Q = \frac{K(H^2 - h_0^2)L}{R}$$

where,

K = Permeability of soil

H = Height of water table

h_0 = height of Infiltration gallery
 L = Length of Infiltration gallery
 R = Distance between water levels

2. Wells

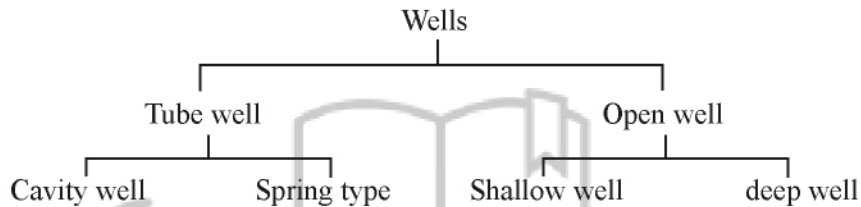
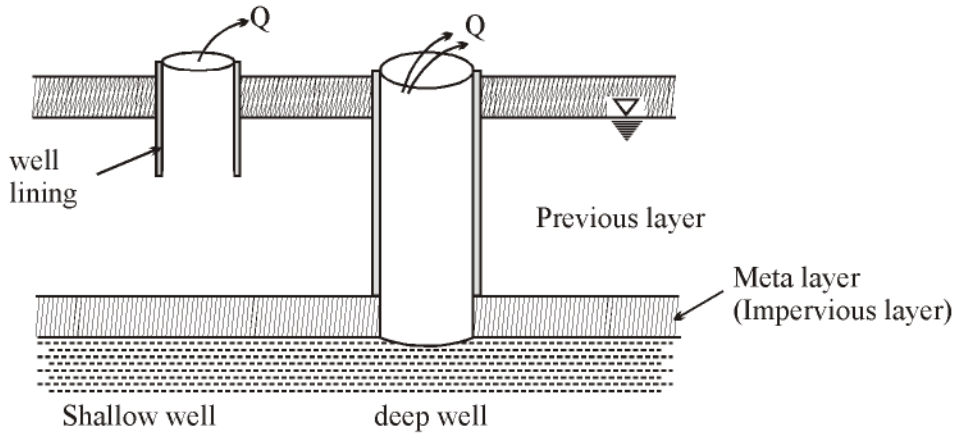

- **Shallow well** : Well lining are resisted by soil friction. It may be deeper than deep well.
- **Deep well** : Well lining rest on the first impervious layer.
- **Cavity Formation** : Due to large discharge from the deep well, upward velocity of flow become more than the critical velocity of flow and hence fine sand is get lifted along the water. More lifting of fine sand cause a cavity below the meta layer.
- It increase the flow area approx $4/3$ times.
- Cavity formation is dangerous in shallow well, as well lining may sink. hence discharge from shallow well is limited.

1.9 | YIELD OF OPEN WELL

Yield at open well correctly calculated by pumping test in the field.

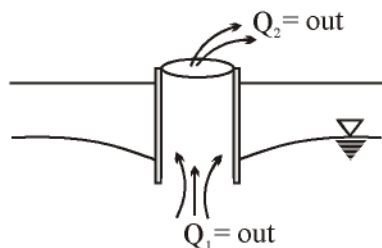

- $Q_1 = Q_2$ = water level maintain
- $Q_1 > Q_2$ = water level increases
- $Q_1 < Q_2$ = water level decreases

1.10 | PUMPING TEST

Pumping causes drawdown thus it is adjusted to make water level constant. Under this equilibrium condition rate of pumping will be equal to rate of yield from the well

$$Q = CAS$$

where,

Q = Discharge

C = Specific capacity per unit area of well

S = Drawdown

A = Area of well (Bottom area)

$$= \frac{\pi}{4}d^2 \text{ (Shallow well)}$$

$$= \frac{4}{3} \times \frac{\pi}{4}d^2 \text{ (for deep well)}$$

If C and A are constant then

$$\frac{Q}{S} = \text{constant.}$$

$$\frac{Q_1}{S_1} = \frac{Q_2}{S_2}$$

The value of 's' for which the velocity become equal to critical velocity (for sand comes out) is called "Critical dispersion head". Working head = $\frac{1}{3}$ critical dispersion head (generally).

□□□

ENGINEERS ACADEMY

2 CHAPTER

Quality Control of Water

THEORY

Water impurities are classified on the basis of following properties

1. Physical Parameter
2. Chemical Parameter
3. Biological Parameter

2.1 | PHYSICAL PARAMETER

1. Suspended solids
2. Turbidity
3. Taste and odour
4. Colour
5. Temperature

1. Suspended Solids

Source : These are called as physical parameters where as dissolved solids are considered as chemical parameters. SS comes from inorganic particles like silt, clay etc., immiscible liquids like oils and greases and organic particles like plant fiber, algae, etc. Inorganic solids are non-degradable solids.

Note: Problem of SS comes only in surface water but not in groundwater.

Objection : These are objectionable because :

- ⊕ Aesthetically displeasing,
- ⊕ It provides adsorption sites for chemical and biological agents
- ⊕ They may also be biologically active and may form disease causing organisms as well as organisms such as toxin producing strains of algae.

➤ **Measurement :**

Most of the methods are gravimetric i.e. SS are calculated by weighing them. Total solids i.e. all solids (suspended or dissolved) are calculated by evaporating the sample and measuring the residue. Heating temperature is 104°C. Suspended solid is obtained by filtration and heating the residue on filter at 104°C.

Dissolved solids (DS) = Total solids (TS) – Suspended solids (SS)

Note : Filtration in real terms does not exactly divides the solids into suspended and dissolved fractions because some colloids may pass through the filter and can get measured along with dissolved fraction.

Hence classification is done as filterable and non-filterable solids.

Hence suspended solids are corresponding to non-filterable solids and dissolved solids are corresponding to filterable solids.

The organic content of both total and dissolved solids can be determined by firing the residue at 650°C.

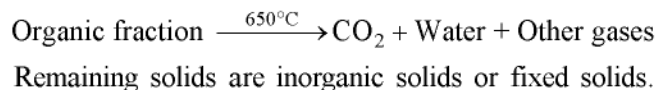

➤ **The permissible limits :**

- ❖ For suspended solid as per EPA is 30 mg/l

2. Turbidity:

- **Definition :** Turbidity is the measure of extent to which light is either absorbed or scattered by suspended material in water. It is not a direct quantitative measure of suspended solids.
- **Objection :** Disinfection of turbid water is difficult because the suspended solids may partially shield the organisms from disinfectant.
- ❖ In natural bodies turbidity interferes with light penetration and hence with the photosynthetic reactions (which gives oxygen to the water).
- **Measurement :** Measurement of turbidity is done using the following :

| | |
|-------------------------|----------------------------|
| (a) Turbidity rod | (b) Jackson's turbidimeter |
| (c) Baylis turbidimeter | (d) Nephelometer |

(a) Turbidity Rod

Rod with platinum needle is inserted inside water and the depth at which platinum needle just becomes invisible gives turbidity in ppm. Turbidity which one milligram of finely divided silica produces in one litre of distilled water is taken as one unit. The permissible limit is 5 to 10 ppm. It is a field method.

Note: Government of India manual gives turbidity in NTU i.e. Nephelometer turbidity unit. Acceptable limit is 1 and cause for rejection is 10.

(b) Jackson's Turbidimeter :

- ❖ The level of water is increased till the image of flame ceases to be seen.
- ❖ The turbidity is measured from graduated glass tube.
- ❖ It is used when turbidity is greater than 25 ppm.
- ❖ It is a laboratory method.

Note: Turbid raw water of natural source has turbidity greater than 25 ppm.

(c) Baylis Turbidimeter and Nephelometer :

Baylis and Nephelometer turbidimeters are based on colour matching techniques. In this case even a small turbidity of one unit or less can be measured. Hence these are most widely used for domestic water supplies. In Baylis turbidimeter light intensity is measured in the direction of incident light only where as in nephelometer light intensity is measured at right angles to the incident ray. Hence NTU is based on scattering principle. If Formazine, a chemical, is used as base in place of SiO₂. The turbidity unit is also sometimes called FTU.

3. Taste and Odour

Taste and odour are caused by dissolved gasses like H₂S (Hydrogen sulphide), mercaptans, methane organic matter derived from certain dead or living micro organism, decomposing organic matter, industrial liquid, water containing phenols, cresols, ammonia, agricultural chemicals, high residual chlorine and chloro-phenols.

➤ **Source :**

- ❖ Sulphur imparts rotten egg like taste and odour.
- ❖ Algae secretes oily substances that may result in bad taste and odour.

➤ **Objection :** The taste and odour causing compounds may be carcinogenic.

➤ **Measurement :**

Measurement of taste and odour causing organics can be done using gas or liquid chromatography. However this method is costly and not done in routine. Intensity of taste and odour is measured by **Threshold Odour Number(TON)**. It represents the dilution ratio at which odour is hardly detectable. TON allowed is between 1 – 3. TON testing is done in cold water because increase in temperature may change the taste and odour. The formula for $TON = \frac{A+B}{A}$ where A is the volume of odourous water in mL and B is the volume of odour free water required to produce a mixture in which odour is hardly detectable. Odours can be removed by mechanical aeration, oxidation by chemicals like chlorine or its compounds or ozone or permanganate and adsorption of odour by agents such as activated carbon, flock or clays.

4. Colour

➤ **Source :** Colour is caused by suspended and dissolved matter in water.

After suspended matter causing colour is removed by centrifugation, the colour obtained is called true colour. Humic acid gives yellowish brown colour, Iron oxide gives reddish colour, manganese oxide gives brown or blackish water. Water containing oxidised iron and manganese impart characteristic reddish or black colour. Heavy growth of algae may also impart colour to the water.

➤ **Objection :**

Coloured water is not suitable for dyeing purpose. Organic compounds causing colour may exert chlorine demand and hence reduces the effectiveness of disinfection by chlorine. Phenolic compound with chlorine produces taste and odour. Some colour causing organic compounds with chlorine becomes carcinogenic.

➤ **Measurement:**

Measurement of colour is done by colour matching technique (tintometer). Result is expressed in TCU or Hazen unit (True colour unit) where 1 TCU is equal to colour produced by 1 mg per litre of platinum in the form of chloroplatinate ion (It is only for yellowish brown colour). For colour other than yellowish brown i.e. from industrial effluent, spectro photometric technique is used. The colour testing is done within 72 hours of collection as effluent biological or physical properties may change.

➤ **Permissible limit :** Acceptable limit is 5 TCU and cause for rejection is 25 TCU

5. Temperature :

Temperature affects the chemical and biological reactions. An increase in 10°C, doubles the biological activity. Hence for water supply, the temperature should be between 10-25°C and greater than 25°C is objectionable.

2.2 | CHEMICAL PARAMETERS

- | | | |
|---------------------------------|-------------------|--------------|
| 1. Total Dissolved Solids (TDS) | 6. Fluorides | 11. Organics |
| 2. Alkalinity | 7. pH | |
| 3. Hardness | 8. Phosphorus | |
| 4. Nitrogen Content | 9. Metals | |
| 5. Chloride Content | 10. Dissolved Gas | |

1. Total Dissolved Solids (TDS)

The material remaining in the water after filtration is considered to be dissolved.

A direct measurement of TDS can be made by evaporating the sample of water which has been filtered (to remove the suspended solids). The residual is weighed and represents the TDS in the water. Approximate analysis of TDS is often made by determining the electrical conductivity of water. (Electrical conductivity in $\mu\text{Mho/cm}$ at 25°C) $\times 0.65 =$ dissolved solid content in mg/l . Electrical conductivity is measured by di-ionic water tester. Ions usually account for vast majority of TDS.

Source of Total dissolved solids

Major source

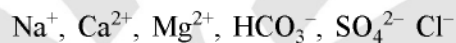

Minor source



Major list characterizes the dissolved solid content of water and these are called common ions.

2. Alkalinity

Alkalinity is defined as quantity of ions in water that will react to neutralize hydrogen ions (H^+). Alkalinity is thus a measure of the ability of water to neutralise acids. Most common constituents of alkalinity are CO_3^{2-} , HCO_3^- , OH^- . Alkalinity caused by CO_3^{2-} is called carbonate alkalinity. Alkalinity caused by HCO_3^- is called bicarbonate alkalinity and alkalinity caused by OH^- is called caustic alkalinity. The other minor sources of alkalinity are HSiO_3^- , H_2BO_3^- , HPO_4^{2-} , HS^- . Alkalinity in water comes due to minerals or it may be produced due to atmospheric CO_2 mixed in water or due to microbial decomposition of organic matter. The reaction are as follows:

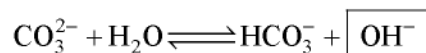
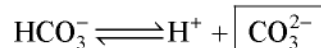
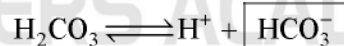
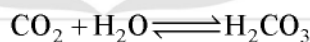

The last reaction is a weak reaction but utilization of HCO_3^- by algae in water drives the reaction to the right and hence sufficient accumulation of OH^- occurs. If algae is present in water, the water becomes alkaline ($\text{pH} = 9$ to 10). The above reactions are due to microbial decomposition of organic matter. In addition to this alkalinity may be of mineral origin. Alkalinity imparts bitter taste to water. The principal objection is that the reaction can occur between alkalinity and certain cations in water. The resultant precipitate can foul pipes and other water system.

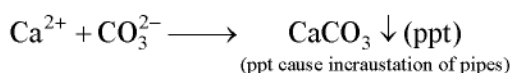

➤ **Measurements :**

Alkalinity measurements are done by titrating the water with an acid and determining the hydrogen equivalent of alkalinity and it is expressed in terms of mg/l as CaCO_3 .

➤ **Dependentibility of Alkalinity on pH Value :**

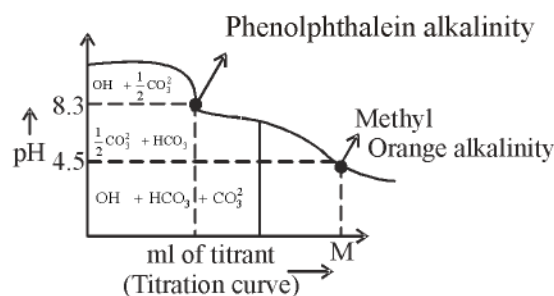

Reaction of alkalinity with hydrogen ion is shown below.



During titration measurement of pH is done at every stage and a titration curve is plotted.

Conversion of CO_3^{2-} to HCO_3^- is essentially complete at $\text{pH} = 8.3$, but resultant HCO_3^- also requires acid. Hence half of CO_3^{2-} is thought of to have been neutralised upto $\text{pH} = 8.3$. Neutralization OH^- is complete

upto $\text{pH} = 8.3$. Hence $\left(\text{OH}^- + \frac{1}{2}\text{CO}_3^{2-}\right)$ alkalinity is completely neutralized upto $\text{pH} = 8.3$. At $\text{pH} = 4.5$

all the bicarbonates will have been converted to carbonic acid H_2CO_3 (neutralised). Hence, the amount of acid required to titrate a sample of water to $\text{pH} = 4.5$ is equivalent to total alkalinity of water.)

⊛ IF $P = M$ all alkalinity is caustic alkalinity.

⊛ IF $P = \frac{M}{2}$, all alkalinity is carbonate alkalinity

⊛ IF $P < \frac{M}{2}$, predominant species are carbonate and bicarbonate

⊛ IF $P > \frac{M}{2}$, predominant species are carbonate and hydroxide

⊛ IF $P = 0$ total alkalinity is bicarbonate alkalinity.

3. Hardness:

It is defined as concentration of multivalent metallic cations in solution. Hardness can be divided in two parts i.e. carbonate hardness and non-carbonate hardness.

HCO_3^- and CO_3^{2-} of calcium and magnesium cause carbonate hardness. It is also called temporary hardness because this hardness can be removed by simple boiling of water in which calcium carbonate precipitates. So it requires to add lime first.

Note: Magnesium carbonate is soluble in water, hence it does not precipitate.

Sulphate, chloride and nitrate of calcium and magnesium gives permanent hardness. It is also called non-carbonate hardness. This hardness cannot be removed by simple boiling. It requires softening techniques. Hard water leads to lesser foam formation, hence consumption of soap would be more. It leads to scaling of boilers. It causes corrosion and incrustation of pipes. It makes food tasteless. Magnesium hardness with sulphate ion have laxative effect. Calcium hardness however does not cause any health problem. Hardness is expressed as CaCO_3 equivalent of Ca^{2+} and Mg^{2+} present in water in mg/litre. Amount of Ca^{2+} and Mg^{2+} in water is determined by titration with versenate solution (EDTA method). In EDTA method water is titrated with ethylene diamine tetra-acetic acid using eriochrome black T (EBT) as an indicator. EBT forms red colour and titration changes the colour to blue. If 0.01 M EDTA is used, 1 ml of the titrant is equivalent to 1 mg of hardness as CaCO_3 . If $[\text{Ca}^{2+}]$ and $[\text{Mg}^{2+}]$ is known in mg/litre, total hardness would be equal to

$$\text{Total Hardness} = \frac{[\text{Mg}^{2+}] \text{ mg/l}}{\text{eq. wt of Mg}^{2+}} \times \text{eq. wt of CaCO}_3 + \frac{[\text{Ca}^{2+}] \text{ mg/l}}{\text{eq. wt of Ca}^{2+}} \times \text{eq. wt. CaCO}_3$$

$$\therefore \text{Total Hardness} = [\text{Ca}^{2+}] \times \frac{50}{20} + [\text{Mg}^{2+}] \times \frac{50}{12}$$

➤ **Degree of hardness of water :**

| <i>Limit (mg/l)</i> | <i>Degree of hardness</i> |
|---------------------|---------------------------|
| 0-55 | Soft |
| 56-100 | Slightly hard |
| 101-200 | Moderately hard |
| 201-500 | Very hard |

➤ **Relation between Alkalinity and Hardness :**

Bicarbonate and carbonate ions in water are usually given by calcium, magnesium and sodium. If NaHCO_3 and Na_2CO_3 are absent (i.e. sodium alkalinity is absent), then carbonate hardness will be equal to alkalinity. But sodium alkalinity will be absent only when SO_4^{2-} and Cl^- of calcium and magnesium are present i.e. Non-carbonate hardness is present (because sodium alkalinity will be converted to calcium and magnesium alkalinity). This implies that if non-carbonate hardness is present, carbonate hardness = alkalinity. If non-carbonate hardness is absent

$$\text{Alkalinity} > \text{Carbonate hardness}$$

$$\therefore \text{Total Hardness} = \text{Carbonate hardness}$$

Hence carbonate hardness is equal to total hardness or alkalinity whenever is less. Non-carbonate hardness is equal to total hardness in excess of alkalinity. Acceptable limit of total hardness = 200 mg/l and

$$\text{Cause for rejection} = 600 \text{ mg/l}$$

4. Nitrogen Content:

- ❖ Presence of nitrogen in water indicates presence of organic matter.
- ❖ It occurs in the form of–
 - (a) Free ammonia → indicates recent pollution
 - (b) Organic ammonia (Albuminoid) → Indicates quantity of nitrogen before decomposition has started.
 - (c) Nitrite (NO_2^-) → Indicates partially decomposed condition
 - (d) Nitrate (NO_3^-) → indicates old pollution (fully oxidised)

Free ammonia should not be more than 0.15 mg/l and it can be measured by simply boiling the water and measuring the liberated ammonia by distillation process. Organic ammonia should not be more than 0.3 mg/l and it is measured by boiling a sample of already boiled water plus strong alkaline solution like KMnO_4 and measuring the ammonia so liberated.

Free ammonia + organic ammonia = Kjeldahl Nitrogen Ammonia.

Nitrite is highly dangerous, hence its permissible limit is zero. It is measured by colour matching technique. (The colour for nitrite is developed by sulphuric acid + Naphtha amine). Nitrate is not harmful as it is fully oxidised. But too much of nitrate affects infants. Because it causes blue baby disease or methemoglobinemia. Nitrate concentration should not be more than 45 mg/l. Its concentration is measured by colour matching technique. Colour is formed by phenol-di-sulphonic acid + Potassium Hydroxide.

5. Chloride Content :

Chlorides in water are derived mostly from natural mineral deposit, agricultural or irrigation discharges. Presence of chloride in high quantity indicates pollution of water due to sewage or industrial water. Chlorides are estimated by titrating water with standard AgNO_3 solution using K_2CrO_4 as indicator. Acceptable limit is 200 mg/l and cause for rejection is 1000 mg/l.

6. Fluorides

Upto 1 mg/l, it helps to prevent dental cavities and during formation of permanent teeth it combines chemically with teeth enamel resulting in harder teeth those are more resistant to decay. Excess value (greater than 1.5 to 2 ppm) results in decolouration of teeth called mottling of teeth. (Infants are affected not adults). Greater than 5 mg/l causes deformation of bones called bone fluorosis. Excessive dosages of fluoride can also result in bone fluorosis and other skeleton abnormalities. Acceptable limit is upto 1 mg/l and greater than 1.5 mg/l is cause for rejection.

7. pH

$\text{pH} = -\log_{10}[\text{H}^+]$ where $[\text{H}^+]$ is in moles/litre. pH is measured by potentiometer in which potential exerted by H^+ is measured. Permissible value of pH in water 6.6 – 8.5 is acceptable limit. It can also be measured by colour indicators. Colour formed is compared with standard colour. Indicators used are methyl orange. Its original colour is red and colour produced is yellow. pH range is 2.8 – 4.4. Methyl orange is an acidic indicator. Phenolphthalein red has pH range of 8.6 – 10.3. Original colour is yellow and final colour is red. Phenolphthalein is a basic indicator. Acidic water causes corrosion and alkaline water causes incrustation of pipe. Alkaline water causes difficulty in chlorination. (Chlorine is a disinfectant).

8. Phosphorus :

- ❖ It is not toxic and do not represent direct health threat. But is indirect threat to water quality facilitates:
 - ⊗ It facilitates rapid growth of aquatic plants.
 - ⊗ It interferes with water treatment like chemical coagulation.
- ❖ (Even a low concentration of 0.2 mg/l interferes with the water treatment process.)

9. Metals :

- ❖ Metals are of two types i.e. toxic and non-toxic.
- ❖ Ca, K, Na, Fe, Mn, Zn are non-toxic metals.

➤ Sodium :

- ❖ Excess Na (sodium) concentration caused bad taste and harmful for cardiac and kidney patients. It is also corrosive to metal surface and in large concentration, it is toxic for plants.
- ❖ Measurements: Atomic absorption spectrophotometry.

➤ Iron and Manganese:

- ❖ Fe and Mn pose colour problem, if concentrations are greater than 0.3 mg/l and 0.05 mg/l respectively.
- ❖ Some bacteria use iron and manganese compounds for an energy source and resulting slime growth which may produce taste and odour.
- ❖ $\text{Fe}(\text{HCO}_3)_2 \xrightarrow{\text{O}_2} \text{Fe}(\text{OH})_3 \downarrow$ (Similarly manganese also precipitates.)

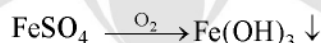
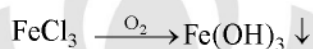

- ❖ Iron and manganese poses problems in ground water and bottom layers of lakes but not in surface water. Because surface water has sufficient O_2 and hence ppt of $\text{Fe}(\text{OH})_3$ and MnO_2 will occur.
- ❖ Acceptable limit for iron is 0.1 – 1.0 mg/l and for Mn 0.05 – 0.5 mg/l.

➤ Copper :

- ❖ Its large quantity affects lungs and respiratory organs.
- ❖ Its limit is 0.05 – 1.5 mg/l
- ❖ CuSO_4 greater than 250 mg/l has laxative effect.
- ❖ Arsenic, barium, cadmium, lead, mercury and silver are toxic metals

10. Dissolved Gas

- ⊗ CH_4 which is studied for its explosive tendency.
- ⊗ H_2S imparts bad taste and odour
- ⊗ CO_2 indicates biological activity, imparts bad taste and water becomes corrosive
- ⊗ Oxygen level less than saturation level indicates oxygen deficiency.
- ❖ To determine oxygen deficiency of water 10% solution of KMnO_4 is exposed to 27°C for 4 hours and the amount of oxygen absorbed is calculated.

11. Organics

- ❖ These are classified as biodegradable and non-biodegradable organics.

➤ *Biodegradable :*

- ❖ Biodegradable organics are utilised for food by naturally occurring microorganisms examples of biodegradable organics are starch, fats, proteins, acids, aldehydes and esters. Microbial utilization of dissolved organic is accompanied by:

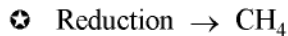
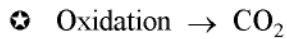

Reaction in the presence of oxygen is called aerobic reaction and reaction in the absence of oxygen is called anaerobic reaction. Aerobic reaction gives stable end products whereas end product of an aerobic reaction is unstable. Amount of oxygen consumed during microbial utilization of organics is called BOD (biochemical oxygen demand) BOD after 5 days at 20°C is taken as standard BOD

$$\text{BOD}_5 = [\text{Initial dissolved oxygen} - \text{Final dissolved oxygen}] \times \text{Dilution factor}$$

$$\text{Where dilution factor} = \frac{\text{Final volume}}{\text{Sample volume}}$$

- ❖ BOD of treated water should be zero.

Note: Sample + pure water is diluted upto 300 ml and initial DO is noted in the diluted sample. The diluted sample is incubated at 20°C for 5 days and final DO is noted. The BOD₅ is calculated.

In BOD test all sources of light are removed otherwise if algae is present, algal growth will take place and in that process oxygen will be released in water.

➤ *Non-biodegradable:*

Examples of non-biodegradable organics are tannic acid, lignin acid and phenols. They are constituents of woody plants. These organics decompose so slowly that they are called non-biodegradable. Besides these molecules with strong bonds are non-biodegradable like benzene, detergent compounds organic pesticides, industrial chemicals. Hydrocarbon combined with chlorine are toxic to organisms hence considered non-biodegradable. Measurement of non-biodegradable organics is done by COD i.e. chemical oxygen demand and also TOC i.e. total organic carbon. Both COD and TOC also measures biodegradable organics. COD is determined by mixing the sample with very strong oxidising agent like $\text{K}_2\text{Cr}_2\text{O}_7$ which oxidises all organic matter. Non-biodegradable organics = COD – BODu.

2.3 | BIOLOGICAL PARAMETERS

The most important organisms are called pathogens. These are capable of transmitting diseases.

Examples are bacteria, virus, protozoan and helminthes.

Pathogenic bacteria can be tested and counted in laboratory but only with great difficulty. Hence these tests are not performed generally in routine.

The usual routine tests are generally conducted to detect and count the presence of coliforms, which in themselves are harmless aerobic organisms but their presence or absence indicates the presence and absence of pathogenic bacteria. Coliform called bacteria coli (B-coli, E-coli) are important harmless aerobic microorganisms which are found residing in the intestine of all warm blooded animals and excreted with their feces. These bacteria live longer in water than pathogenic bacteria. Hence if coliform is absent pathogens would be absent.

The tests for coliforms are:

1. Membrane filter technique
2. MPN test (most probable number)
3. Coliform index.

1. Membrane Filter Technique:

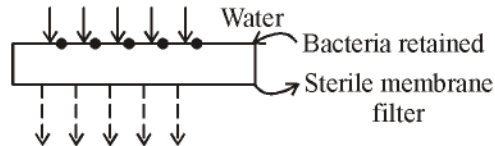

Water sample is poured on the sterile membrane filter. (Porosity 80%; size 5 to 10 μ m)

- ❖ Membrane is that put in contact with nutrients that permits the growth of only coliform colony. After incubation for 20 hrs number of visible colonies are counted.

2. MPN Test

Mix different dilutions of a sample of water with lactose broth and incubate them in test tubes at 37°C for 48 hours (other substances which inhibit the growth of non-coliform organism is also added. The presence of acid or carbon dioxide in the test tube will indicate presence of coliform bacteria. Coliform actually is believed to ferment lactose and the end products are acid and CO₂. Then referring to standard table MPN of B-coil per 100 ml of water is found out. MPN represents bacterial density which is most likely to be present. Say 10 ml, 1 ml and 0.1 ml dilution samples are taken and 5 number of test tubes with each dilution are tested. If positive test is seen in 4 no. of 100 ml samples, 2 No. of 1 ml sample, and 2 No. of 0.1 ml sample then from standard table MPN per 100 ml is obtained from 4-2-2.

3. Coliform Index

It is defined as the reciprocal of smallest quantity of a sample which will give positive B-coli test. MPN and B-coli index are now obsolete.

2.4 | WATER BORNE DISEASES

- Bacteria:**
- (i) Typhoid fever (salmonella bacteria typhi)
 - (ii) cholera (vibrio cholera bacteria)
 - (iii) Bacillary dysentery (Sonne bacillus)
- Virus:**
- (i) Jaundice (Hepatitis virus)
 - (ii) Polio myelitis
- Pratozoa :**
- (i) Amoebic dysentery

Nuisance Bacteria :

- ❖ Iron Bacteria: It causes pitting and tuberculation in pipes and renders water unsuitable for industrial purposes.
- ❖ Sulphur bacteria: Acid produced during their metabolism is destructive to concrete and other structures.

□□□