



MP – Vyapam

Electrical Engineering

Madhya Pradesh Employees Selection Board (MP ESB)

Volume - 5

---

Power System & Measurement



# INDEX

S No.	Chapter Title	Page No.
1	Generation of Electrical Power	1
2	Modelling of Transmission Line	13
3	Symmetrical Fault Analysis	37
4	Power System Protection	43
5	Corona	58
6	Cable & Insulator	62
7	Utilization of Electrical Power	71
8	Characteristics of Instrument and Measurement Systems	94
9	Analog Instruments	97
10	AC Bridges	117
11	Measurement of Power & Energy	127
12	Cathode Ray Oscilloscope	134
13	Instrument Transformer	141
14	Miscellaneous	146

# 1 CHAPTER

## Generation of Electrical Power

### THEORY

#### 1.1 | GENERATION OF ELECTRICAL ENERGY

The conversion of energy available in different forms in nature into electrical energy is known as **generation of electrical energy**.

Energy is available in various forms from different natural sources such as pressure head of water, chemical energy of fuels, nuclear energy of radioactive substances etc. All these forms of energy can be converted into electrical energy by the use of suitable arrangements. The arrangement essentially employs (See figure) an alternator coupled to a prime mover. The prime mover is driven by the energy obtained from various sources such as burning of fuel, pressure of water, force of wind etc. for example, chemical energy of a fuel (e.g., coal) can be used to produce steam at high temperature and pressure. The steam is fed to a prime mover which may be a steam engine or a steam turbine. The turbine converts heat energy of steam into mechanical energy which is further converted into electrical energy by the alternator. Similarly, other forms of energy chain be converted into electrical energy by employing suitable machinery and equipment.

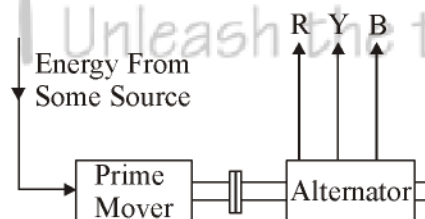

#### 1.2 | SOURCE OF ENERGY

Since electrical energy is produced from energy available in various forms in nature, it is desirable to look into the various sources of energy. These sources of energy are :

(i) The sun (ii) The wind (iii) Water (iv) Fuels (v) Nuclear energy.

Out of these sources, the energy due to Sun and Wind has not been utilized on large scale due to a number of limitations. At present, the other three sources viz., water, fuels and nuclear energy are primarily used for the generation of electrical energy.

### **1.3 | GENERATING STATIONS**

Bulk electric power is produced by special plants known as generating stations or power plants.

A generating station essentially employs a prime mover coupled to an alternator for the energy from some other form into mechanical energy. The alternator converts mechanical energy of the prime mover into electrical energy. The electrical energy produced by the generating station is transmitted and distributed with the help of conductors to various consumers. It may be emphasized here that apart from prime mover-alternator combination, a modern generating station employs several auxiliary equipment and instruments to ensure cheap, reliable and continuous service.

Depending upon the form of energy converted into electrical energy, the generating stations are classified as under :

- (i) Steam power stations
- (ii) Hydroelectric power stations
- (iii) Diesel power stations
- (iv) Nuclear power stations

### **1.4 | STEAM POWER STATION (THERMAL STATION)**

A generating station which converts heat energy of coal combustion into electrical energy is known as a steam power station.

A steam power station basically works on the Rankine cycle. Steam is produced in the boiler by utilizing the heat of coal combustion. The steam is then expanded in the prime mover (i.e., steam turbine) and is condensed in a condenser to be fed into the boiler again. The steam turbine drives the alternator which converts mechanical energy of the turbine into electrical energy. This type of power station is suitable where coal and water are available in abundance and a large amount of electric power is to be generated.

#### **1.4.1 Important Components of Steam Power Station**

Although steam power station (or thermal power station) simply involves the conversion of heat of coal combustion into electrical energy, yet it embraces many arrangements for proper working and efficiency. The following are the important components of a steam power station :

1. Coal and ash handling arrangement
2. Steam generating plant
3. Steam turbine
4. Alternator
5. Feed water
6. Cooling arrangement

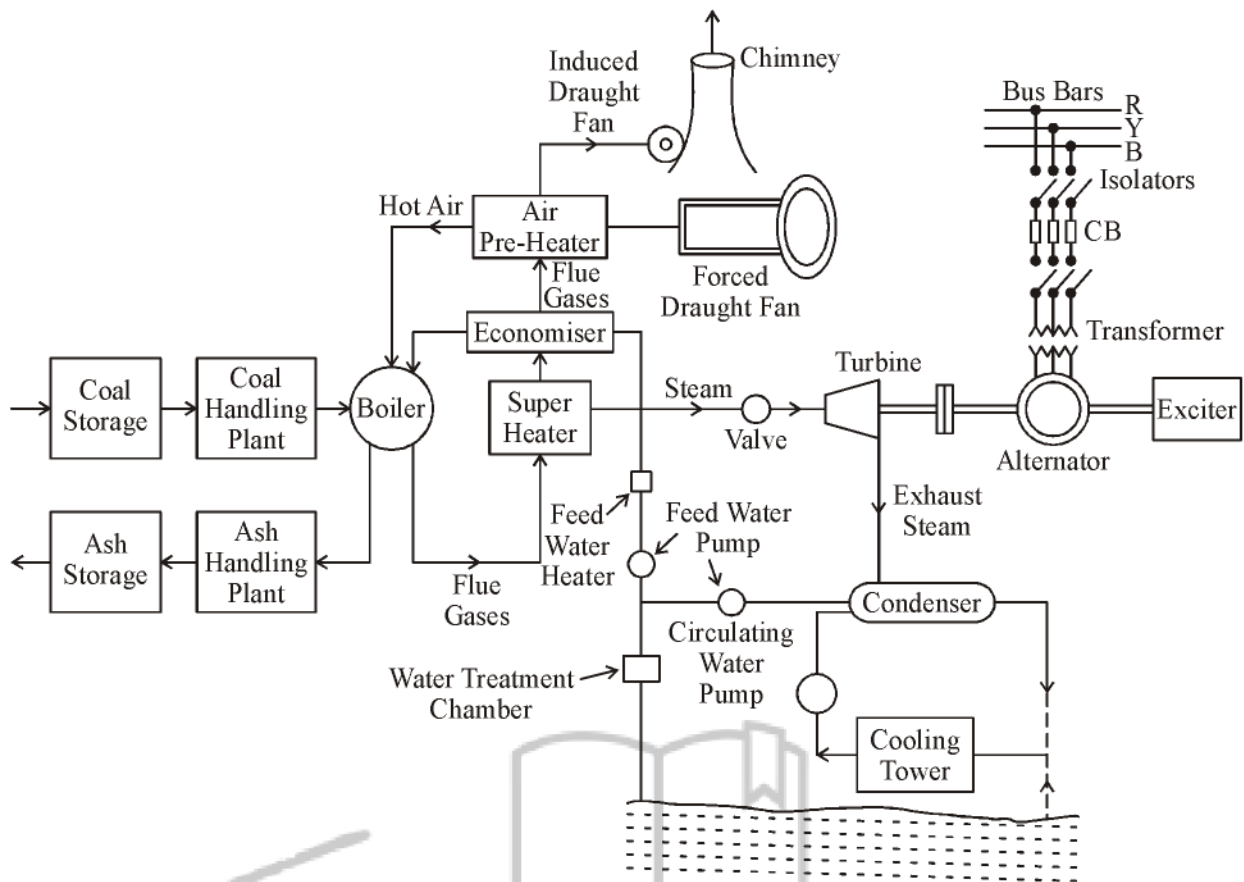

1. **Coal and ash handling plant :** The coal is transported to the power station by road or rail and is stored in the coal storage plant. Storage of coal is primarily a matter of protection against coal strikes, failure of transportation system and general coal shortages. From the coal storage plant, coal is delivered to the coal handling plant where it is pulverized (i.e., crushed into small pieces) in order to increase its surface exposure, thus promoting rapid combustion without using large quantity of excess air. The pulverized coal is fed to the boiler by belt conveyors. The coal is burnt in the boiler and the ash produced after the complete combustion of coal is removed to the ash handling plant and then delivered to the ash storage plant for disposal. The removal of the ash from the boiler furnace is necessary for proper burning of coal.
2. **Steam generating plant.** The steam generating plant consists of a boiler for the production of steam and other auxiliary equipment for the utilization of flue gases.
  - (i) **Boiler.** The heat of combustion of coal in the boiler is utilized to convert water into steam at high temperature and pressure. The flue gases from the boiler make their journey through superheater, economizer, air pre-heater and are finally exhausted to atmosphere through the chimney.
  - (ii) **Superheater.** The steam produced in the boiler is wet and is passed through a superheater where it is dried and superheated (i.e., steam temperature increased above that of boiling point of water) by the flue gases on their way to chimney. Superheating provides two principal benefits. Firstly, the overall efficiency is increased. Secondly, too much condensation in the last stages of turbine (which would cause blade corrosion) is avoided. The superheated steam from the superheater is fed to steam turbine through the main valve.

- (iii) **Economiser.** An economiser is essentially a feed water heater and absorb heat from the flue gases for this purpose. The feed water is fed to the economiser before supplying to the boiler. The economiser extracts a part of heat of flue gases to increase the feed water temperature.
  - (iv) **Air preheater.** An air preheater increases the temperature of the air supplied for coal burning by deriving heat from flue gases. Air is drawn from the atmosphere by a forced draught fan and is passed through air preheater before supplying to the boiler furnace. The air preheater extracts heat from flue gases and increases the temperature of air used for coal combustion. The principal benefits of preheating the air are: increased thermal efficiency and increased steam capacity per square meter of boiler surface.
3. **Steam turbine:** The dry and superheated steam from the superheater is fed to the steam turbine through main valve. The heat energy of steam when passing over the blades of turbine is converted into mechanical energy. After giving heat energy to the turbine, the steam is exhausted to the condenser which condenses the exhausted steam by means of cold water circulation.
  4. **Alternator:** The steam-turbine is coupled to an alternator. The alternator converts mechanical energy of turbine into electrical energy. The electrical output from the alternator is delivered to the bus-bars through transformer, circuit breakers and isolators.
  5. **Feed water:** The condensate water from the condenser is used as feed water to the boiler. Some water may be lost in the cycle which is suitably made up from external source. The feed water on its way to the boiler is heated by water heaters and economiser. This helps in raising the overall efficiency of the plant.
  6. **Cooling arrangement:** In order to improve the efficiency of the plant, the steam exhausted from the turbine is condensed by means of a condenser. Water is drawn from a natural source of supply such as a river, canal or lake and is circulated through the condenser. The circulating water takes up the heat of the exhausted steam and itself becomes hot. This hot water coming out from the condenser is discharged at a suitable location down the river. In case the availability of water from the source of supply is not assured throughout the year, cooling towers are used. During the scarcity of water in the river, hot water from the condenser is passed on to the cooling towers where it is cooled. The cold water from the cooling tower is reused in the condenser.

#### **Advantages**

- (i) The fuel (i.e., coal) used is quite cheap.
- (ii) Less initial cost as compared to other generating stations.
- (iii) It can be installed at any place irrespective of the existence of coal. The coal can be transported to the site of the plant by rail or road.
- (iv) It requires less space as compared to the hydroelectric power stations.

#### **Disadvantages**

- (i) It pollutes the atmosphere due to the production of large amount of smoke and fumes.
- (ii) It is costlier in running cost as compared to hydroelectric plant.

#### **1.4.2 Efficiency of Steam Power Station**

The overall efficiency of a steam power station is quite low (about 25-35%) due to mainly two reasons. Firstly, a huge amount of heat is lost in the condenser and secondly heat losses occur at various stages of the plant. The heat lost in the condenser cannot be avoided. It is because heat energy cannot be converted into mechanical energy without temperature difference. The greater the temperature difference,

the greater is the heat energy converted into mechanical energy. This necessitates to keep the steam in the condenser at the lowest temperature. But we know that greater the temperature difference, greater is the amount of heat lost. This explains for the low efficiency of such plants.

- (i) **Thermal efficiency.** The ratio of heat equivalent of mechanical energy transmitted to the turbine shaft to the heat of combustion of coal is known as thermal efficiency of steam power station.

$$\text{Thermal efficiency, } \eta_{\text{thermal}} = \frac{\text{Heat equivalent of mech. energy transmitted to turbine shaft}}{\text{Heat of coal combustion}}$$

The thermal efficiency of a modern steam power station is about 30%. It means that if 100 calories of heat is supplied by coal combustion, then mechanical energy equivalent of 30 calories will be available at the turbine shaft and rest is lost. It may be important to note that more than 50% of total heat of combustion is lost in the condenser. The other heat losses occur in flue gases, radiation, ash etc.

- (ii) **Overall efficiency.** The ratio of heat equivalent of electrical output to the heat of combustion of coal is known as overall efficiency of steam power station i.e.

$$\text{Overall efficiency, } \eta_{\text{overall}} = \frac{\text{Heat equivalent of electrical output}}{\text{Heat of combustion of coal}}$$

The overall efficiency of a steam power station is about 25-35%. It may be seen that overall efficiency is less than the thermal efficiency. This is expected since some losses (about 1%) occur in the alternator. The following relation exists among the various efficiencies.

$$\text{Overall efficiency} = \text{Thermal efficiency} \times \text{Electrical efficiency}$$

## 1.5 | HYDRO-ELECTRIC POWER STATION

A generating station which utilizes the potential energy of water at a high level for the generation of electrical energy is known as a hydroelectric power station.

Hydro-electric power stations are generally located in hilly areas where dams can be built conveniently and large water reservoirs can be obtained. In a hydroelectric power station, water head is created by constructing a dam across a river or lake. From the dam, water is led to a water turbine. The water turbine captures the energy in the falling water and changes the hydraulic energy (i.e., product of head and flow of water) into mechanical energy at the turbine shaft. The turbine drives the alternator which converts mechanical energy into electric energy. Hydroelectric power stations are becoming very popular because the reserves of fuels (i.e., coal and oil) are depleting day by day. They have the added importance for flood control, storage of water for irrigation and water for drinking purposes.

### 1.5.1 Schematic Arrangement of Hydro-Electric Power Station

Although a hydroelectric power station simply involves the conversion of hydraulic energy into electrical energy, yet it embraces many arrangements for proper working and efficiency. The schematic arrangement of a modern hydroelectric plant is shown in Fig.

The dam is constructed across a river or lake and water from the catchment area collects at the back of the dam to form a reservoir. A pressure tunnel is taken off from the reservoir and water brought to the valve house at the start of the penstock. The valve house contains main valve and automatic isolating valves. The former controls the water flow to the power house and the latter cuts off supply of water when the penstock bursts. From the valve house, water is taken to water turbine through a huge steel

pipe known as penstock. The water turbine converts hydraulic energy into mechanical energy. The turbine drives the alternator which converts mechanical energy into electrical energy.

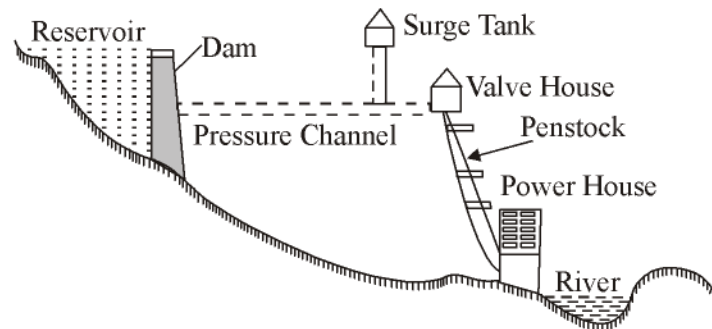

Schematic Arrangement of a Hydro-electric Plant

A surge tank (open from top) is built just before the valve house and protects the penstock from bursting in case the turbine gates suddenly close due to electrical load being thrown off. When the gates close, there is a sudden stopping of water at the lower end of the penstock and consequently the penstock can burst. The surge tank absorbs this pressure swing by increase in its level of water.

**Water turbines.** Water turbine are used to convert the energy of falling water into mechanical energy. The principal types of water turbines are :

- (a) **Impulse turbines:** Such turbines are used for high heads. In an impulse turbine, the entire pressure of water is converted into kinetic energy in a nozzle and the velocity of the jet drives the wheel. It consists of a wheel fitted with elliptical buckets along its periphery. The force of water jet striking the buckets on the wheel drives the turbine. The quantity of water jet falling on the turbine is controlled by means of a needle or spear placed in the tip of the nozzle. The movement of the needle is controlled by the governor. If the load on the turbine decreases, the governor pushes the needle into the nozzle, thereby reducing the quantity of water striking the buckets. Reverse action takes place if the load on the turbine increases.
- (b) **Reaction turbines:** Reaction turbines are used for low and medium heads. In a reaction turbine, water enters the runner partly with pressure energy and partly with velocity head. The important types of reaction turbines are:
  - (i) **Francis turbine:** A Francis turbine is used for low to medium heads. It consists of an outer ring of stationary guide blades fixed to the turbine casing and an inner ring of rotating blades forming the runner. The guide blades control the flow of water to the turbine. Water flows radially inwards and changes to a downward direction while passing through the runner.
  - (ii) **Kaplan turbine :** A kaplan turbine is used for low heads and large quantities of water. It is similar to Francis turbine except that the runner of Kaplan turbine receives water axially. Water flows radially inwards through regulating gates all around the sides, changing direction in the runner to axial flow. This causes a reaction force which drives the turbine.

### Advantages

- (i) It requires no fuel as water is used for the generation of electrical energy.
- (ii) It is quite neat and clean as no smoke or ash is produced.
- (iii) It requires very small running charges because water is the source of energy which is available free of cost.

- (iv) It is comparatively simple in construction and requires less maintenance.
- (v) It does not require a long starting time like a steam power station. In fact, such plants can be put into service instantly.
- (vi) It is robust and has a longer life.
- (vii) Such plants serve many purposes. In addition to the generation of electrical energy, they also help in irrigation and controlling floods.
- (viii) Although such plants require the attention of highly skilled persons at the time of construction, yet for operation, a few experienced persons may do the job well.

#### **Disadvantages**

- (i) It involves high capital cost due to construction of dam.
- (ii) There is uncertainty about the availability of huge amount of water due to dependence on weather conditions.
- (iii) Skilled and experienced hands are required to build the plant.
- (iv) It requires high cost of transmission lines as the plant is located in hilly areas which are quite away from the consumers.

## **1.6 | NUCLEAR POWER STATION**

A generating station in which nuclear energy is converted into electrical energy is known as a nuclear power station.

In nuclear power station, heavy elements such as Uranium ( $U^{235}$ ) or Thorium ( $Th^{232}$ ) are subjected to nuclear fission in a special apparatus known as a reactor. The heat energy thus released is utilised in raising steam energy into mechanical energy. The turbine drives the alternator which converts mechanical energy into electrical energy.

The most important feature of a nuclear power station is that huge amount of electrical energy can be produced from a relatively small amount of nuclear fuel as compared to other conventional types of power stations. It has been found that complete fission of 1 kg of Uranium ( $U^{235}$ ) can produce as much energy as can be produced by the burning of 4,500 tons of high grade coal. Although the recovery of principal nuclear fuels (i.e., Uranium and Thorium) is difficult and expensive, yet the total energy content of the estimated world reserves of these fuels are considerable higher than those of conventional fuels, viz., coal, oil and gas. At present, energy crisis is gripping us and, therefore, nuclear energy can be successfully employed for producing low cost electrical energy on a large scale to meet the growing commercial and industrial demands.

### **1.6.1 Important Components of Nuclear Power Station**

The important components of a nuclear power station are:

- (a) Nuclear reactor (b) Heat exchanger (c) Steam turbine (d) Alternator
- (a) **Nuclear reactor:** It is an apparatus in which nuclear fuel ( $U^{235}$ ) is subjected to nuclear fission. It controls the chain reaction that starts once the fossil is done. If the chain reaction is not controlled, the result will be an explosion due to the fast increase in the energy released.

A nuclear reactor is a cylindrical stout pressure vessel and houses fuel rods of Uranium, moderator and control rods. The fuel rods constitute the fission material and release huge amount of energy when bombarded with slow moving neutrons. The moderator consists of graphite rods which enclose the fuel rods. The moderator slows down the neutrons before they bombard the fuel rods. The control rods are of cadmium and are inserted into the reactor. Cadmium is strong neutron absorber and thus regulates the supply of neutrons for fission. When the control rods are pushed in deep enough, they absorb most of fission neutrons and hence few are available for chain reaction which, therefore, stops. However, as they are being withdrawn, more and more of these fission neutrons cause fission and hence the intensity of chain reaction (or heat produced) is increased. Therefore, by pulling out the control rods, power of the nuclear reactor is increased. Whereas by pushing them in, it is reduced. In actual practice, the lowering or raising of control rods is accomplished automatically according to the requirement of load. The heat produced in the reactor is removed by the coolant, generally a sodium metal. The coolant carries feed water pump.

- (d) **Alternator.** The steam turbine drives the alternator which converts mechanical energy into electrical energy. The output from the alternator is delivered to the bus-bars through transformer, circuit breakers and isolators.

#### **Advantages**

- (i) The amount of fuel required is quite small. Therefore, there is a considerable saving in the cost of fuel
- (ii) A nuclear power plant requires less space as compared to any of the type of the same size.
- (iii) It has low running charges as a small amount of fuel is used for producing bulk electrical energy.
- (iv) This type of plant is very economical for producing bulk electric power.
- (v) There are large deposits of nuclear fuels available all over the world. Therefore such plants can ensure continued supply of electrical energy for thousands of years.
- (vi) It ensures reliability of operation.

#### **Disadvantages**

- (i) The fuel used is expensive and is difficult to recover.
- (ii) The capital cost on a nuclear plant is very high as compared to other types of plants
- (iii) The erection and commissioning of the plant requires greater technical know-how.
- (iv) The fission by-products are generally radioactive and may cause a dangerous amount of radioactive pollution.
- (v) Maintenance charges are high due to lack of standardization. Moreover, high salaries of specially trained personnel employed to handle the plant further raise the cost.
- (vi) Nuclear power plants are not well suited for varying loads as the reactor does not respond to the load fluctuations efficiently.
- (vii) The disposal of the by-products, which are radioactive, is a big problem. They have either to be disposed off in a deep trench or in a sea away from seashore.

## 1.7 | LOAD CHARACTERISTICS

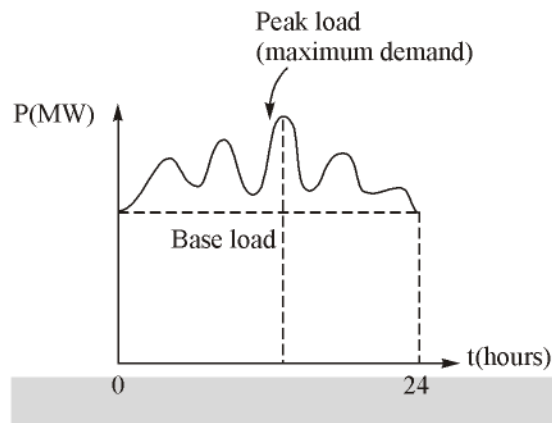

**Load Curve:** Graph between the power demand of the system with respect to the time in hours. It is also called daily load curve.

If time is given in months it is called monthly load curve.

If time is given in year it is called yearly load curve.

**Base Load:** The average load available through the 24 hours is called Base load. For supplying the base load demand diesel, thermal, nuclear plant are used. Hydro plants are used for base load in case of rainy season.

**Peak Load :** The max load above the base load is called peak load. For supplying the peak load demand. Pumped storage plant is used, hydro plant are used as peak load in case of summer season.

## 1.8 | IMPORTANCE OF LOAD CURVE IN POWER GENERATION

1. It gives variation of the load during different hours of the day.
2. The area under the curve represents the total number of units generated in a day.
3. The area under the load curve divided by the number of hours represented by average load on the power station.

**Average load**

$$\text{Average load} = \frac{\text{Total energy consumed during a day}}{\text{Time in hours}}$$

$$\text{Load factor} = \frac{\text{Average load}}{\text{Maximum demand}}$$

Practically load factor < 1

$$\text{Demand factor} = \frac{\text{Maximum demand}}{\text{Connected load}}$$

**Connected Load :** The sum of continuous ratings of all electrical equipment connected to the supply system.

## Diversity Factor

$$\text{Diversity factor} = \frac{\text{Sum of individual maximum demand}}{\text{Coincident maximum demand}}$$

Diversity factor is greater than unity.

## Capacity Factor

$$\text{Capacity factor} = \frac{\text{Maximum demand}}{\text{Rated capacity}}$$

## Reserve Capacity

$$\text{Reserve capacity} = \text{Rated capacity} - \text{Maximum demand}$$

## Plant Factor or Utilization Factor

$$\begin{aligned}\text{Utilization factor} &= \frac{\text{Average load}}{\text{Rated capacity}} \\ &= \frac{\text{Average load}}{\text{M.D.}} \times \frac{\text{M.D.}}{\text{Rated capacity}}\end{aligned}$$

i.e.

$$\text{U.F} = \text{L.F} \times \text{C.F}$$

Where L.F. is Load factor and C.F. is capacity factor.

**Significance of Load Factor and Diversity Factor :** Higher the values of load factor and diversity factor, lower will be the overall cost per unit generated.

Higher load factor means greater average load, resulting in generator number of units generated for a given maximum demand. Thus standing charges which is proportional to maximum demand and independent of numbers of units generated can be distributed over a large number of units supplied & therefore overall cost per unit of electrical energy generated will be reduced.

With a given number of consumers the higher the diversity of their loads the smaller will be the capacity of plant required thus fixed charges due to capital investment will be reduced.

## 1.9 | Types of Consumers and Their Tariffs

	Demand Factor	Diversity Factor
Domestic lighting upto 1 kW	0.5-0.7	3-5
Domestic power	0.5	1.5-2
Commercial loads (lightly)	0.5-0.7	1.5-2
Industrial power	0.5-0.8	1.5-2

The main type of load on a system are domestic, commercial agricultural, industrial, municipal, traction etc. Accordingly the consumers may be categorised as domestic consumers, commercial consumers, agricultural consumers, industrial consumers (small, medium and large), bulk consumers etc.

### 1.9.1 Domestic Consumers

Residential load consists of lights, fans and appliances such as radios, TVs, heaters, electric irons, refrigerators, water heaters, washing machines, coolers, air-conditioners, domestic pump sets etc. Domestic consumers are given single phase supply up to a load of 5 kW and a 3-phase supply for loads exceeding 5 kW.

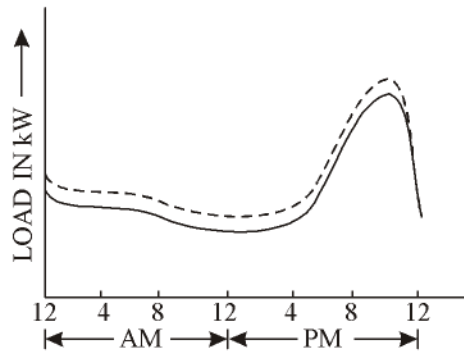

Typical Chronological Load Curve For Domestic Consumer

### 1.9.2 Commercial Consumers

Non-residential premises, such as shops, business-houses, cinemas, hotels, public offices, clubs etc. fall under this category. The load mainly consists of lights, fans and small electric appliances.

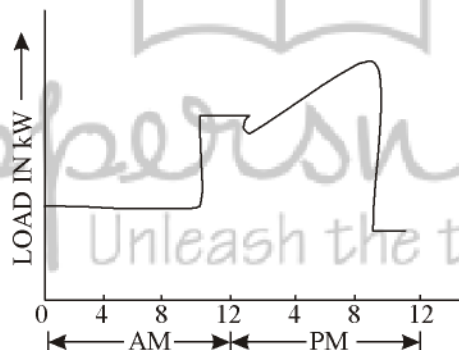

Typical Chronological Load Curve For Commercial Consumers

### 1.9.3 Agricultural Consumers

Consumers drawing power up to 20 kW for irrigation pumping units are categorized as agricultural consumers. Such consumers are given a three phase supply. The loads of the tubewells used for irrigation constitute a substantial portion of the system load. The demand factor and diversity factor are both almost unity.

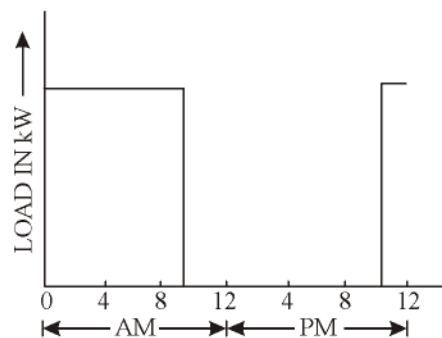

Typical Chronological Load Curve For Agricultural or Irrigation

### 1.9.4 Industrial Consumers

Industrial consumers may further be categorised as small industrial consumers, medium industrial consumers and large industrial consumers according to the rating of loads.

Small industrial consumers are owners of small workshops, atta chakkis, wheat threshers, saw machines and other small manufacturing and repair shops with load not exceeding 20 kW.

Industrial consumers with loads exceeding 20 kW but not exceeding 100 kW fall under the category of medium industrial consumers. They are given three phase supply at 415 V and are usually charged on two part tariff.

Industrial consumers with loads exceeding 100 kW are categorized as large industrial consumers. They are supplied power at 11 or 33 kV, and in rare cases, at 415 V three phase depending on the requirement of the consumers.

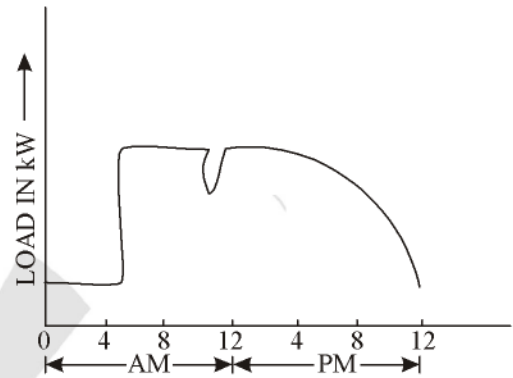

Typical Chronological Load Curve For Industrial load

### 1.9.5 Bulk Consumers

Power consumers such as railways, public work departments, educational institutions, military establishments, hospitals having loads exceeding 100 kW fall under the category of bulk consumers. Bulk consumers are usually supplied by 3-phase supply at 415 V or 11 kV depending on their requirements. Such consumers are charged at flat rate.

### 1.9.6 Street Lighting

Power supply given for the lighting of parks, roads and streets under the municipal committees, municipal boards or panchayats comes under this category. Supply for street lighting is given at 415 V three phase or 240 V single phase. Such a load has demand factor and diversity factor of unity.

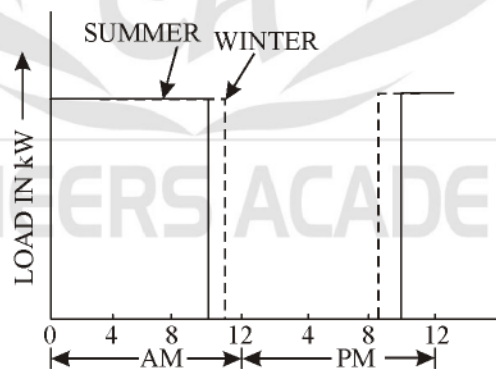

Typical Chronological Load Curve For Street Lighting

### 1.9.7 Water Supply

The load for water supply is for pumping water to the overhead tanks. It is generally possible to fit this load during system off peak hours, usually during night hours.



# 2 CHAPTER

# Modelling of Transmission Line

## THEORY

### 2.1 | PARAMETERS PERFORMANCE

A particular conductor of cross-sectional area 'A' and length 'l' having resistance R.

$$R = \rho \frac{l}{A}$$

⇒

$$R = \frac{l}{\sigma A}$$

$\rho$  → Resistivity

$\sigma$  → Conductivity

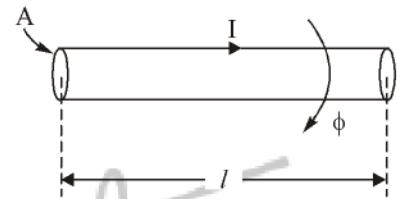

Whenever a current is passed through a conductor it produces a flux 'φ'.

Where,

$$\lambda \propto I$$

⇒

$$\lambda = LI$$

So there exists an inductance also

$$L = \frac{\lambda}{I}; L \rightarrow \text{Inductance}$$

There is some capacitance exists between two conductors where air behaves as insulator (dielectric). Practically ideal dielectric can't exist in nature, so there must be dielectric loss and losses are represented by shunt conductance

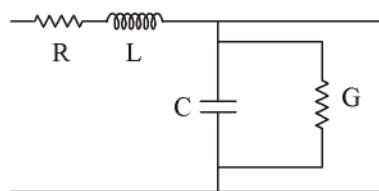

G → Shunt conductance

So there are four parameters R, L, C, G in power line. In power line transmitted power is represented in "MW" and dielectric loss will be in "Watt". So as compared to power transferred dielectric loss is negligible i.e. leakage is neglected.

All the transmission line contains resistance and inductance and in between the conductors there is capacitance and shunt conductance present through out the transmission line. So that R, L, C, G are called as “distributed parameters”.

## 2.2 | CLASSIFICATION OF TRANSMISSION LINE

1. Short Line < 80 km
2. Medium Line  $80 < \text{km} < 200$
3. Long Line  $> 200$  km

### 2.2.1 Short Line

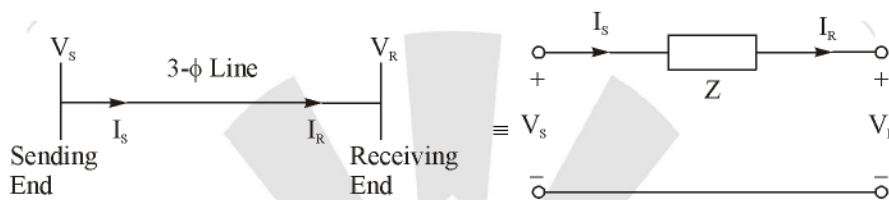

Total series impedance

$$\bar{Z} = R + jX_L = R + j\omega L$$

$V_S \rightarrow$  Sending end voltage

$V_R \rightarrow$  Receiving end voltage

$I_S \rightarrow$  Sending end current

$I_R \rightarrow$  Receiving end current

According to the diagram

$$V_S = V_R + ZI_R \quad \dots(i)$$

and

$$I_S = I_R \quad \dots(ii)$$

Transmission Parameter

$$V_S = AV_R + BI_R \quad \dots(iii)$$

$$I_S = CV_R + DI_R \quad \dots(iv)$$

Equation (i) and (ii) also written as

$$V_S = 1 \cdot V_R + Z \cdot I_R$$

$$I_S = 0 \cdot V_R + 1 \cdot I_R$$

When compare with equation (iii) and (iv)

$$A = D = 1$$

$$B = Z$$

$$C = 0$$

$$\begin{bmatrix} V_S \\ I_S \end{bmatrix} = \begin{bmatrix} 1 & Z \\ 0 & 1 \end{bmatrix} \begin{bmatrix} V_R \\ I_R \end{bmatrix}$$

In case of no load

∴  $I_R = 0$   
 $V_S = V_R$   
 i.e.  $V_{R(\text{no load})} = V_S$

Voltage regulation 
$$V.R. = \frac{V_{R(nf)} - V_{R(f)}}{V_{R(f)}} \times 100 = \frac{V_S - V_R}{V_R} \times 100$$

When load is connected

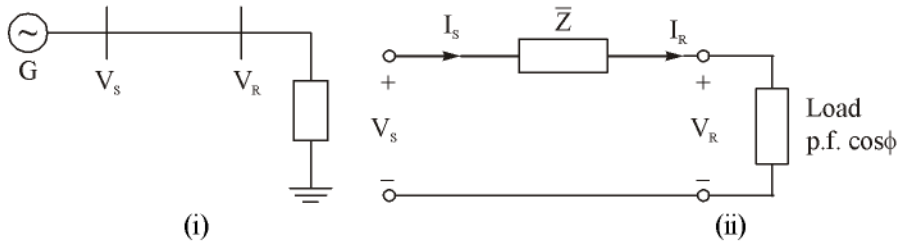

At lagging power factor  $\cos\phi$ , receiving end current  $I_R$  lags  $V_R$  by angle  $\phi$ .

Phasor diagram 
$$\bar{V}_S = \bar{V}_R + \bar{I}_R R + j \bar{I}_R X$$

Step-(i) : Draw  $V_R$  along X-axis i.e. reference phase



Step-(ii) :  $I_R$  lags  $V_R$  by angle.

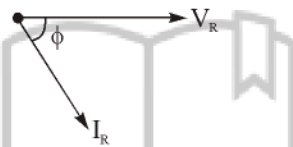

Step (iii) : Add  $\bar{I}_R R$  with  $\bar{V}_R$

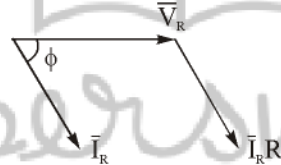

Step (iv) : Add  $j \bar{I}_R X_L$  with  $\bar{I}_R R$

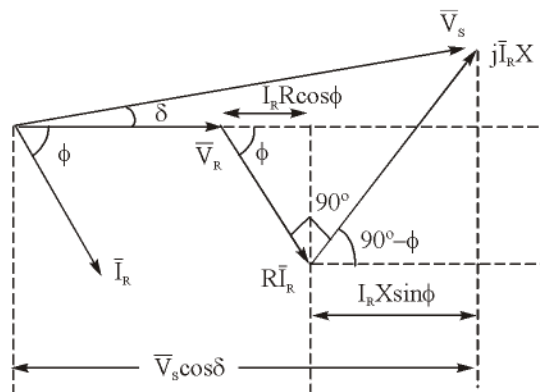
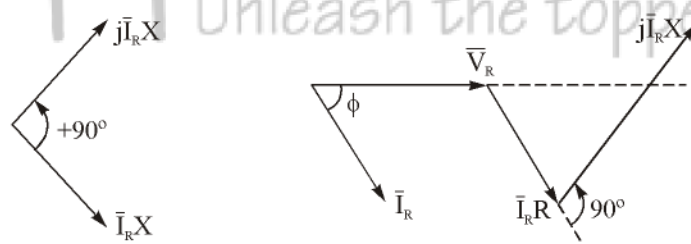

As per diagram  $|\bar{V}_S| \cos \delta = |\bar{V}_R| + |\bar{I}_R| R \cos \phi + |\bar{I}_R| X \sin \phi$

Due to transient stability criterion the value of 'δ' is small, so that  $\cos \delta \approx 1$

$$\therefore |\bar{V}_S| = |\bar{V}_R| + |\bar{I}_R| (R \cos \phi + X \sin \phi)$$

$$\Rightarrow |\bar{V}_S| - |\bar{V}_R| = |\bar{I}_R| (R \cos \phi + X \sin \phi)$$

$$\Rightarrow \frac{|\bar{V}_S| - |\bar{V}_R|}{|\bar{V}_R|} = \frac{|\bar{I}_R|}{|\bar{V}_R|} (R \cos \phi + X \sin \phi)$$

$$\text{Voltage regulation} = (R_{pu} \cos \phi + X_{pu} \sin \phi)$$

i.e. + for lagging p.f.

– for leading p.f.

### Case-1

For maximum voltage regulation

(It is worst regulation)

$$\frac{dV_R}{d\phi} = 0$$

At lagging power factor  $\cos \phi$

$$\Rightarrow \frac{|\bar{I}_R|}{|\bar{V}_R|} \frac{d}{d\phi} [R \cos \phi + X \sin \phi] = 0$$

$$\Rightarrow -R \sin \phi + X \cos \phi = 0$$

$$\Rightarrow X \cos \phi = R \sin \phi$$

$$\Rightarrow \tan \phi = \frac{X}{R}$$

$$\phi = \tan^{-1} \left( \frac{X}{R} \right)$$

### Case-2

For zero voltage regulation

$$\frac{|\bar{I}_R|}{|\bar{V}_R|} [R \cos \phi - X \sin \phi] = 0$$

$$\Rightarrow \tan \phi = \frac{R}{X}$$

$$\phi = \tan^{-1}\left(\frac{R}{X}\right)$$

Voltage regulation and power factor curve

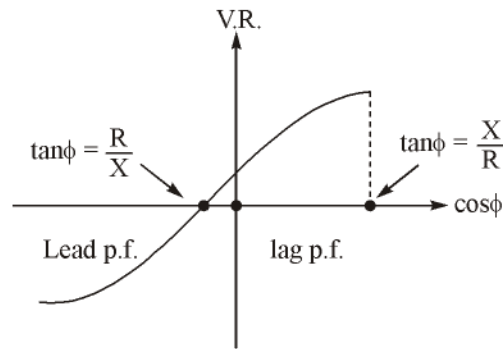

### 2.2.2 Medium Line Model

Nominal  $\pi$ -model:

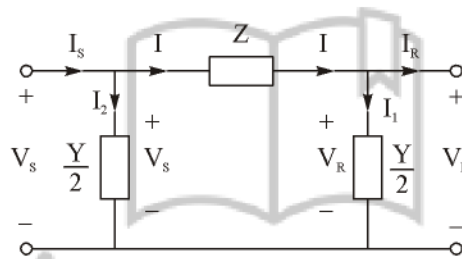

According to the diagram

$$I_1 = \frac{Y}{2} V_R$$

$$I = I_R + I_1$$

$$V_S = V_R + IZ$$

$\Rightarrow$

$$V_S = V_R + Z \left[ I_R + \frac{Y}{2} V_R \right]$$

$\therefore$

$$V_S = \left( 1 + \frac{YZ}{2} \right) V_R + Z I_R$$

$$I_2 = \frac{Y}{2} V_S; \quad I_S = I + I_2$$

$$I_S = I + \frac{Y}{2} V_S$$

$\Rightarrow$

$$I_S = Y \left[ 1 + \frac{YZ}{4} \right] V_R + \left[ 1 + \frac{YZ}{2} \right] I_R$$

$$A = D = 1 + \frac{YZ}{2}$$

$$B = Z$$

$$C = Y \left[ 1 + \frac{YZ}{4} \right]$$

Similarly in case of T-model

$$A = D = 1 + \frac{YZ}{2}$$

$$B = Z \left[ 1 + \frac{YZ}{4} \right]$$

$$C = Y$$

### 2.3 | CHARACTERISTIC IMPEDANCE OR SURGE IMPEDANCE

$$Z_0 = \sqrt{\frac{Z}{Y}} = \sqrt{\frac{R + j\omega L}{G + j\omega C}}$$

For lossless line

$$R = 0, G = 0$$

$$Z_0 = \sqrt{\frac{L}{C}} \Omega \text{ (Real number)}$$

∴

$$Z_0 = \text{Pure resistance}$$

3-φ power

$$P_R = 3 |V_R|_{(ph)} |I_R|_{(ph)} \cos 0^\circ = 3 \frac{|V_R|_{ph}^2}{Z_0}$$

or, (Surge impedance loading) 
$$SIL = P_r(3-\phi) = 3 \frac{|V_R|_{ph}^2}{Z_0} = 3 \frac{\left( \frac{|V_R|_L}{\sqrt{3}} \right)^2}{Z_0}$$

$$P_{R(3-\phi)} = \frac{|V_R|_L^2}{Z_0}$$

**Graphical Analysis:**

(i) If

$$Z_L = Z_0$$

$$|V_S| = |V_R|$$

i.e. flat voltage profile occurs.