



**UKPSC – JE**

**Electrical Engineers**

**Uttarakhand Public Service Commission (UKPSC)**

**Volume - 1**

**(Technical)**

**Electrical Machines**



# INDEX

| S No. | Chapter Title  | Page No. |
|-------|--|----------|
| 1     | Transformers   | 1        |
| 2     | Electromechanical Energy Conversion Principles       | 71       |
| 3     | DC Machine   | 81       |
| 4     | Induction Motors                                     | 140      |
| 5     | Three Phase Synchronous Machines                     | 197      |
| 6     | Fractional kW Motors & Single Phase Induction Motors | 262      |

# 1 CHAPTER

# Transformers

## THEORY

### 1.1 COMPARISON BETWEEN MAGNETIC AND ELECTRIC CIRCUITS

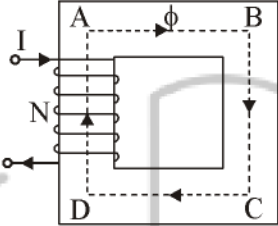
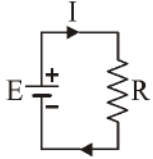
| Parameters                | Magnetic Circuit  | Electric Circuit  |
|---------------------------|---|---|
| Circuit                   |                                  |                            |
| 1. Definition             | The closed path followed by magnetic flux is called a magnetic circuit  | The closed path followed by an electric current is called an electric circuit.                                |
| 2. Driving force          | MMF is required to establish flux $\phi$ in the magnetic circuit and is measured in ampere-turns (AT) or amperes. | EMF is required to cause flow of current in an electric circuit and is measured in volts.                     |
| 3. Response               | $\text{Flux, } \phi = \frac{\text{Driving force}}{\text{Magnetic reluctance}}$ $= \frac{AT}{S} \text{ webers}$    | $\text{Current, } I = \frac{\text{Driving force}}{\text{Electric resistance}}$ $= \frac{E}{R} \text{ ampere}$ |
| 4. Impedance              | Reluctance, $S = \frac{l}{\mu_0 \mu_r a} = \frac{l}{\mu a} \text{ AT/Wb}$   | Resistance, $R = \rho \frac{l}{a} \text{ ohms}$   |
| (a) For series circuits   | $S = S_1 + S_2 + S_3 + \dots$   | $R = R_1 + R_2 + R_3 + \dots$   |
| (b) For parallel circuits | $S = \frac{1}{\frac{1}{S_1} + \frac{1}{S_2} + \frac{1}{S_3} + \dots}$   | $R = \frac{1}{\frac{1}{R_1} + \frac{1}{R_2} + \frac{1}{R_3} + \dots}$   |

|                             |   |  |
|-----------------------------|---|--|
| 5. Admittance               | Permeance = $\frac{1}{\text{Reluctance}}$ in Wb/AT  | Conductance = $\frac{1}{\text{Resistance}}$ in siemens                                       |
| 6. Proportionality constant | Reluctivity = $\frac{1}{\text{Permeability}} = \frac{1}{\mu}$ in m/H  | Resistivity, $\rho = \frac{1}{\text{Conductivity}}$ in $\Omega\text{-m}$                     |
| 7. Density                  | Flux density,<br><br>$B = \mu \times \text{magnetic field intensity}$<br><br>$= \mu H$ tesla or $\text{Wb/m}^2$ | Current density,<br><br>$J = \frac{\text{Electric field intensity}}{\rho}$ in $\text{A/m}^2$ |
| 8. Field intensity          | Magnetic field intensity,<br><br>$H = \frac{\text{MMF}}{\ell} = \frac{NI}{\ell}$ in AT/m                        | Electric field intensity<br><br>$= \frac{E}{\ell}$ in volts/meter                            |
| 9. Drop                     | MMF drop = $\phi \times \text{reluctance} = \phi S$   | Voltage drop = $I \times \text{Resistance} = IR$   |

### DISSIMILARITIES

|  |  |
|--|--|
| 1. Flux does not actually flow in a magnetic circuit.  | Current does flow in an electric circuit.  |
| 2. Permeability does not largely vary from material to material and there is hardly any material which can act as an insulator to the magnetic flux.                 | Conductivity varies largely from material to material so much so that some materials are insulators to electric current and some are very good conductors.   |
| 3. For a particular temperature the permeability depends up on the flux density (or total flux).   | For a particular temperature, conductivity (or resistivity) is constant and independent of current strength.   |
| 4. Flux can pass through air.  | Current would not flow through the air until an arc is struck.   |
| 5. Residual flux persists after removal of mmf.  | The current is reduced to zero after removal of source of emf.   |
| 6. There is no waste of energy due to reluctance in the magnetic circuit and, therefore, energy is required only to create the magnetic flux but not to maintain it. | In an electric circuit, resistance causes heat to be generated resulting in waste of energy and, therefore, energy is required as long as the current flows. |

## 1.2 TRANSFORMER CONSTRUCTION

The transformer is very simple in construction and consists of magnetic circuit linking with two windings known as primary and secondary windings.

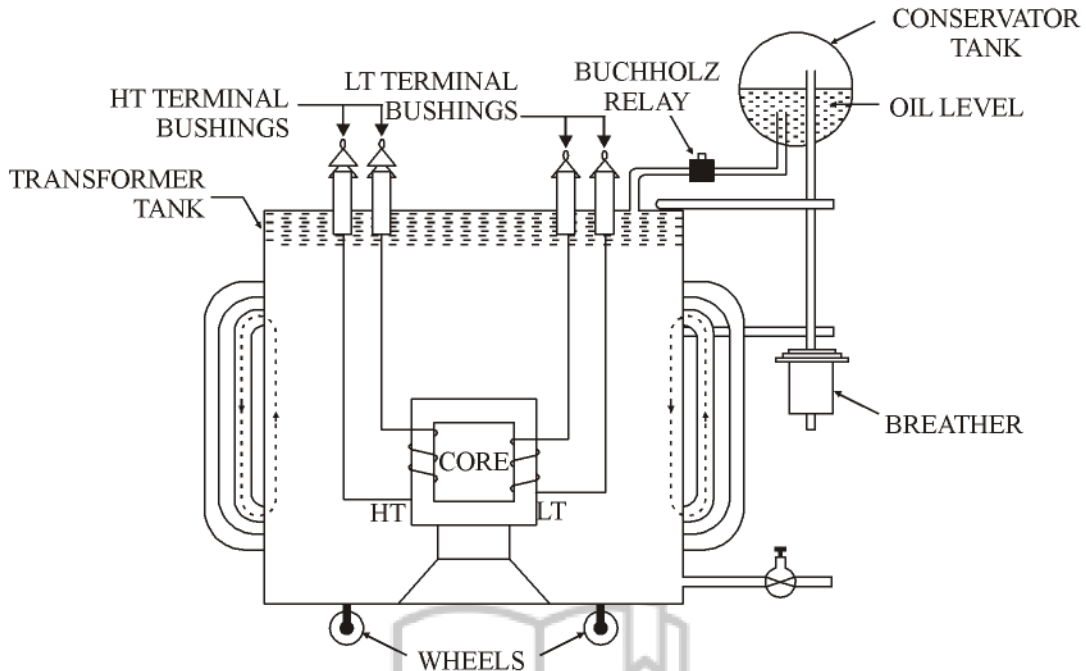

- 1. Core Construction:** A transformer core is the steel system which forms the magnetic circuit with all parts pertaining to its construction. Those parts of the magnetic circuit, which carry the transformer windings are called the limbs or legs, and those parts which connect the legs and serve for closing the magnetic circuit are termed yokes.

The use of steel in magnetic circuit introduces iron or core loss but ensures a high permeability of the magnetic circuit. Because of high permeability the magnitude of exciting current necessary to create the required flux in the core, is small. The magnetic frame (cores and yokes) of the transformer is built up of laminated electro-technical steel. The transformer grade steel consisting of 3.5% silicon.

The steel used for transformer cores may be hot rolled or cold rolled. The hot rolled steel which permitted a maximum flux density of 1.45 T was in use for a considerable length of time. In recent years this type of steel has been completely superseded by cold rolled steel allowing much higher flux densities up to 1.8 T to be used because it has better magnetic properties in the direction of rolling. Although, cold rolled steel is 25-35% more expensive than the hot rolled steel and needs special methods of core assembly. As the flux in the cores is pulsating one, it becomes necessary that the transformer cores are laminated and the laminations should be insulated and made as thin as practicable in order to reduce the eddy current loss or a minimum.

The thickness of laminations or stamping varies from 0.35mm to 0.5mm. The thickness should not be made below 0.35mm because in that case, the laminations become mechanically weak and tend to buckle. As a rule, the cores of high-capacity power transformers (for more than 100 kVA) are assembled of 0.5mm steel sheets, since such a construction is less labour consuming than with 0.35mm sheets. The laminations are insulated from each other by a very thin coating of varnish or by using 0.03mm thick paper. Paper insulation is much cheaper than varnish, but its heat resisting and heat-conducting properties and mechanical strength are worse. Besides, paper insulation occupies too large a percentage of the stack cross section. For this reason in high capacity power transformers, where these drawbacks are significant, varnish insulation is used.

**2. Windings :** Transformer windings are made of solid or stranded Copper or Aluminium strip conductors. Heavy current capacity needs conductors of large cross section. To reduce eddy current losses in the conductors, several small wires or parallel straps are preferred to one large strap.

On small transformers rectangular concentric coils are practical, but in a large unit the high repulsion forces generated between the primary and secondary coils under short-circuit conditions tend to "round out" the flat sides of the outer coil, if this happens, the resulting damage to the coil insulation will usually make the transformer unserviceable. Cylindrical concentric coils are the obvious answer to this problem of mechanical strength.

According to their arrangement high and low voltage windings can be either concentric (i.e., the windings, which in each cross section are circles with a common centre or sandwich, in which parts of the hv and lv windings alternate along the height of the leg. Concentric windings are employed in core type transformers as shown in fig (b). Whereas sandwiched windings are almost exclusively used in shell type transformers as shown in fig (f). On account of the easier insulation facilities, the low-voltage windings is placed nearer to the core in the case of concentric windings and on the outside positions in the case of sandwiched windings. The insulation spaces between low and high-voltage coils also serve to facilitate cooling.

The concentric windings used for core types of transformers can further be classified in many groups, the most important are (i) cylindrical windings, (ii) helical winding, (iii) crossover windings and (iv) continuous disc winding. (v) sandwich windings

**(i) Cylindrical Windings :** These windings are layered type and use either rectangular (or strip) or round conductors. If the cross section of a turn does not exceed 8 to 10 mm<sup>2</sup>, the cylindrical winding is made multi-layer of round conductor for a larger turn cross section the winding is made of rectangular (or strip) conductor, usually double layer. Cylindrical windings with strip conductors is shown in Fig (a). The winding is made up of turns helically wound round the cylinder generatrix with the turns close to each other.

The cylindrical windings using circular conductors are mainly employed for hv windings with voltages 6.6, 11 or 33 kV for ratings up to 600–1000 kVA whereas those using round conductors are mainly employed for low-voltage windings up to 6.6 kV for ratings up to 600-750 kVA.

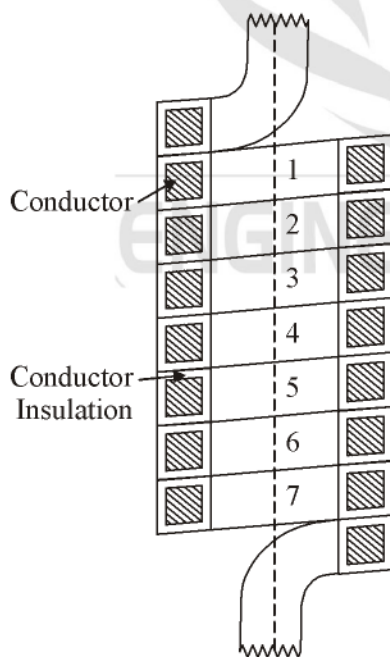

Fig. (a)

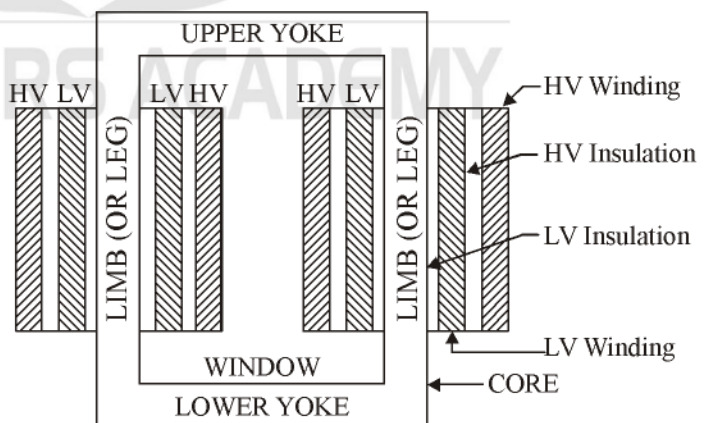

Fig. (b)

(ii) **Helical Windings** : Such windings are employed for lv coils of medium and high capacity transformers where the number of coil turns is small but the current is high (as high as 2,000 A).

Basically the helical winding is the same as the cylindrical windings except that in such windings between adjacent turns axial spacers are provided for duct formation to improve oil circulation for better cooling. The ducts are formed by spacers placed all the way round the periphery of the cylinder at regular intervals as shown in fig. (c).

Helical windings are employed in power transformers of rating ranging from 150 kVA to 30 MVA at voltages from 400V to 11kV and sometimes up to 33kV.

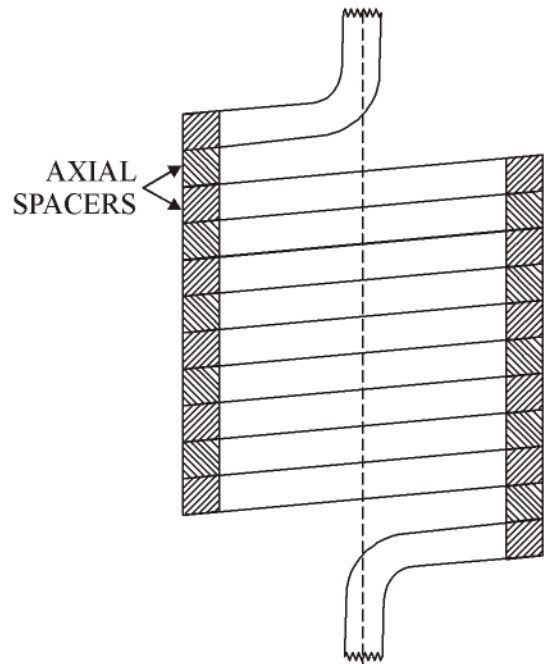
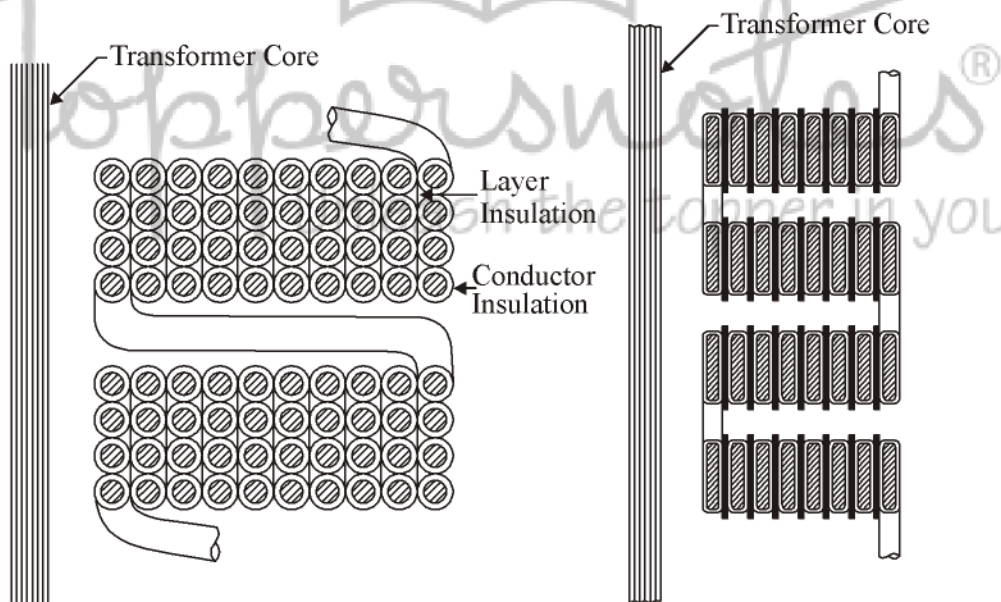

Fig. (c)

(iii) **Cross-over Windings** : Such windings are suitable for currents not exceeding 20A and are very largely employed for hv windings of low rating transformers where number of turns may be large but conductors are of small circular section with double cotton covering or paper covering.

The coil ends, one from inside and one from outside, are joined to other similar coils in series, spaced with blocks of insulating material to allow free circulation of oil.



(d) Cross-over Winding

(e) Continuous Disc Winding

(iv) **Continuous Disc Windings** : The disc coils, as their name suggests, consist of a number of flat coils or discs connected in series or parallel. The coils are formed with rectangular strips wound spirally from centre outwards in the radial direction, as illustrated in Fig. (e).

Continuous disc windings are reliable and strong and, therefore, they are widely employed both as lv and hv windings in large rating transformers.

- (v) **Sandwich Windings** : Such windings, as already mentioned, are most commonly employed in shell type transformers and allow easy control over leakage reactance. Leakage reactance can be reduced by subdividing the low and high voltage windings into a large number of sections or coils and arranging alternatively the hv and lv sections with the lv section nearer to the yoke, as illustrated in fig (f).

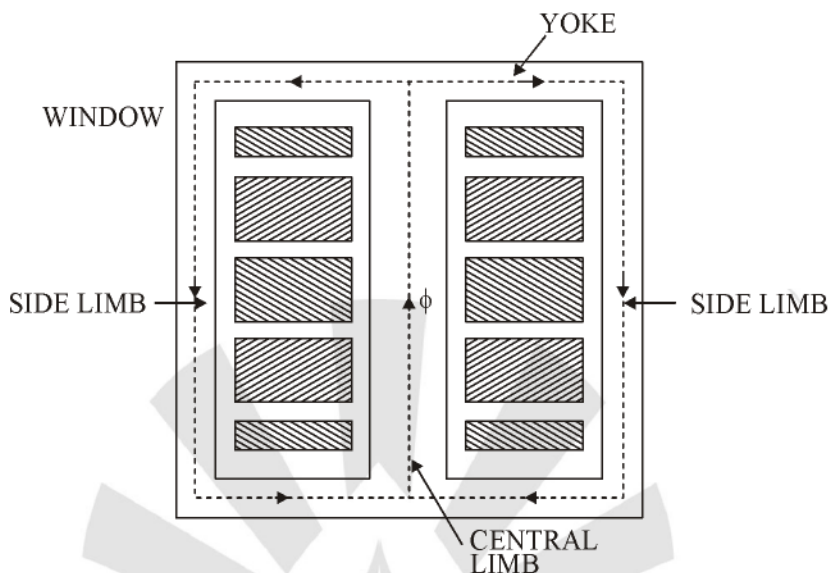

Fig. (f)

In comparison to concentric windings they have several drawbacks such as they are more labour consuming in manufacture, less stable in respect to short circuits and are more difficult to insulate from each other and from the yoke. This is the reason why the core type transformers with concentric windings are more common.

3. **Insulation** : Insulation used in a transformer may be classified into two parts major insulation and minor insulation. The insulation provided between windings and earthed parts (insulation provided between lv winding and core and between hv winding and yoke) and the insulation between the windings (insulation between primary and secondary windings) fall into the category of major insulation. In the interleaved construction the major insulation between windings usually consists of sheets of pressboard and oil ducts. Minor insulation includes the insulation provided between the elements of a given winding such as conductor insulation, insulation between turns, layers and coils. The minor insulation between the coils of the same winding usually consists of pressboard sheets and oil ducts. For very small units treated cloth or fibre may be used.

4. **Insulating Oil** : The insulating oil has three functions. It provides additional insulation, protects the insulation from dirt and moisture and it carries away the heat generated in the cores and coils.

It is obtained by fractional distillation of crude petroleum. Vegetable and animal oils are not used in transformers as they form fatty acids that attack the fibrous insulating materials used.

(i) High dielectric strength

(ii) Low viscosity to provide good heat transfer

(iii) **Purity** : The oil must not contain impurities such as acid, alkali and sulphur or its compounds to prevent corrosion of metal parts and insulation. Sulphur compounds, if present accelerate the formation of sludge.

(iv) **High flash point** : The temperature at which oil vapour ignites spontaneously is called the flash point. The flash point of transformer oil should not be less than 135°C.

(v) Free from sludging under normal operating conditions. Sludging means slow formation of semi-solid hydrocarbon owing to heating and oxidation. The sludge deposits itself on windings, tank walls and in cooling ducts. Sludges, being bad conductor of heat, greatly reduce the heat transfer from the windings to the oil and so increases the temperature of windings. Sometimes for preventing sludging certain chemicals called the inhibitors are added to the transformer oil.

(vi) Good resistance to emulsion so that the oil may throw down and moisture entering the apparatus instead of holding it in suspension.

5. **Tank** : Small capacity tanks are fabricated from welded sheet steel, while larger ones are assembled from plain boiler plates or cast-aluminium parts, usually mounted on a shallow fabricated steel base.

6. **Conservator or Expansion Tank** : The oil expands with the increase in load and contracts when the load decreases. Large power transformers are also liable to overloads which may overheat the oil and consequently there is a sludge formation if air is present.

This causes vapourisation of a part of the oil. The oil vapours form explosive mixture with air that ignites and may cause a considerable damage. For these reasons it is necessary to prevent the oil from having contact with air as well as moisture. For this purpose conservators are employed.

When the oil expands, the air is expelled out and air is drawn inside under contraction of oil. This process is termed breathing. Thus the oil is in contact with air.

Conservator is a small auxiliary oil tank (an airtight cylindrical metal drum) that may be mounted above the transformer and connected to the main tank by a pipe. Its function is to keep the main tank of the transformer completely filled with oil in all circumstances despite expansion or contraction of oil with the changes in temperature, conservator is always partly filled with oil and absorbs the expansion and contraction of oil and keeps the main tank full of oil. It also reduces the rate of oxidation of oil, partly because less oil surface is exposed to air and partly because of the reduced temperature of the oil exposed to air. Thus the sludge formation is considerably reduced and whatever sludge is formed settles to the bottom of the expansion chamber into a sludge pan from where it is periodically withdrawn by means of a drain tap. Normally the capacity of conservator should be approximately 10-12% of the oil volume of the main tank.

The expansion tank is usually installed on the low-voltage side of the transformer tank above the level of the transformer cover on a supporting frame.

7. **Breather** : When the transformer becomes warm, the oil and gas expand. The gas at the top of the oil is expelled out. When the transformer cools, air is drawn into the transformer. Unless preventive measures are taken, moisture is drawn during this process, called the breathing. This moisture is readily absorbed by the oil, and the dielectric properties of the oil are correspondingly reduced. The air entering the transformer is made moisture free by letting it pass through an apparatus called the breather. A breather consists of a small container connected to the vent pipe and contains a dehydrating material like silica gel crystals impregnated with cobalt chloride. The material is blue when dry and a whitish pink when damp. The colour can be observed through a glass window provided in front of container.

8. **Gas operated Relay - Buchholz Relay** : It is a gas and oil actuated protective device and it is practically universally used on all oil-immersed transformers having rating more than 500 kVA. It is installed in the pipe joining the main tank of the transformer to the conservator and is used to give alarm in case of minor fault and to disconnect the transformer from supply mains in case of severe internal fault. The use of such a relay is possible only with transformers having conservators.

When minor faults occur, heat is produced due to current leakage, some of the oil in the transformer tank evaporates and some vapour collects in the top of the chamber while passing to the conservator.

When a predetermined amount of vapour accumulates in the top of the chamber, the oil level falls, the mercury type switch attached to the float is tilted and closes the alarm circuit to ring the bell.

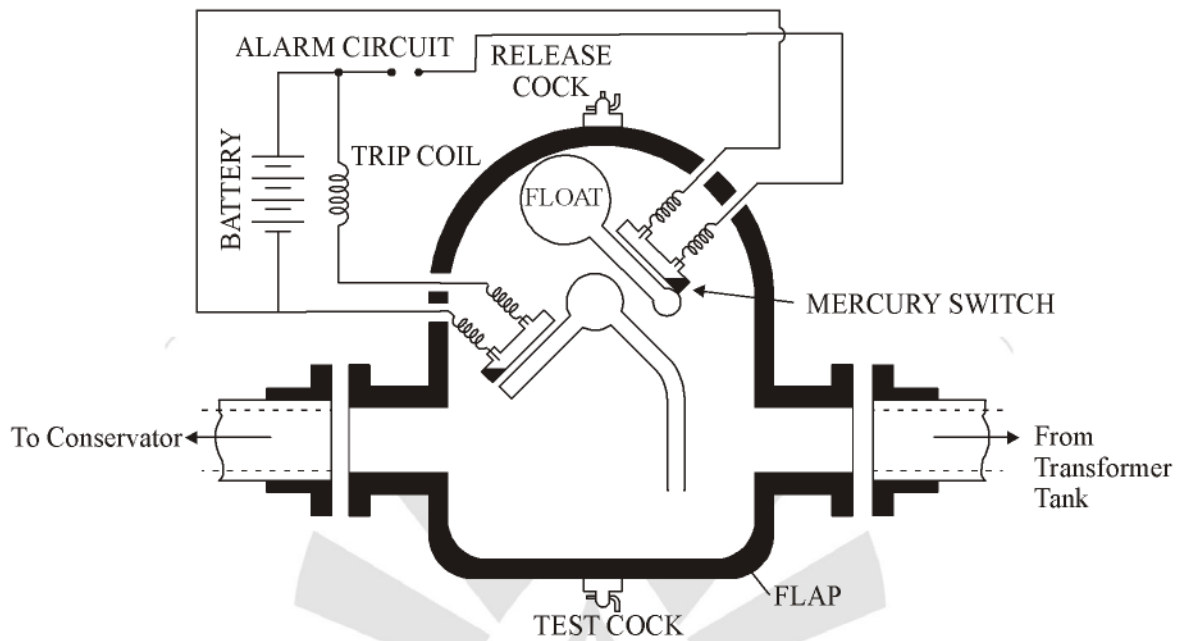

*Fig. Gas operated relay*

9. **Leads and Terminals :** The connections to the windings are by copper rods or bars, insulated wholly or in part, and taken to the bus-bars directly in the case of air cooled transformer, or to the insulator bushings mounted on the top of the transformer tank in case of oil cooled transformers.
10. **Bushings :** The bushing consists of a current carrying element in the form of a conducting rod, and a porcelain cylinder installed in the hole of the cover of the transformer and employed to isolate the current carrying element. Up to 33kV, ordinary porcelain insulators can be used. Above this voltage oil-filled or condenser type bushings are used.
11. **Tappings :** The transformers are usually provided with few tappings so that output voltage can be varied over a small range for constant input voltage. Most industrial transformers are provided with four tappings on the hv winding.

**Transformer :**

A Transformer is a static device comprising coupled coils (Primary and Secondary) wound on common magnetic Core.

MMF (F)

$$F = NI \text{ Amp. turns}$$

Let the mean core length =  $l$

$$\text{Flux density} = B, \text{ Flux } \phi = BA$$

A = Area of cross-section of core.

Magnetization force or magnetic field intensity (H)

$$H = \frac{NI}{l} \text{ ATs / m}$$

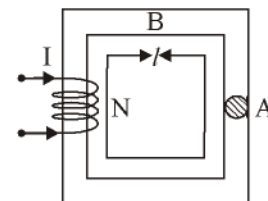

### 1.3 MAGNETIC HYSTERESIS CURVE

If ac current is made to flow through coil in the magnetic circuit shown above  $i = I_m \sin \omega t$

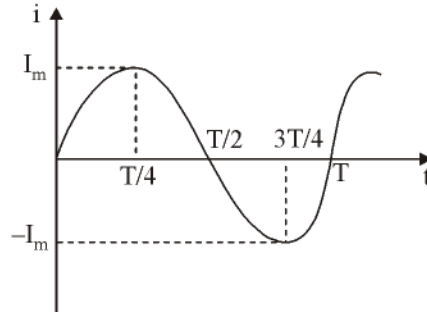

Time period  $T = \frac{1}{f} = \frac{2\pi}{\omega}$

Where  $\omega = 2\pi f$  is frequency

Let initially  $B = 0$  (i.e. residual magnetism is absent)

For  $0 < t < \frac{T}{4}$  where  $i$  increases from zero to  $I_m$  initially  $B$  increases linearly with  $H$  (or  $i$ ) and after a certain value of  $H$ ,  $B$  doesn't increase significantly i.e.  $B$  remains almost constant i.e. saturation.

For linear magnetic circuit

$B \propto H$

$\Rightarrow B = \mu H$

$\Rightarrow B = \mu_0 \mu_r H$

Where  $\mu$  = Permeability of iron core

$\mu_r$  = Relative permeability of core

$\mu_0$  = Permeability free space =  $4\pi \times 10^{-7}$  H/m

Flux linking  $\phi = BA = \mu HA = \mu A \times \frac{Ni}{l}$  ( $H = \frac{Ni}{l}$ )

$\Rightarrow \phi = \frac{Ni}{l} = \frac{f}{Rl}$

Where  $f = Ni$  (mmf in Amp-Turns) applied

$Rl = \frac{l}{\mu A}$  reluctance of core

mmf = Magneto-Motive Force

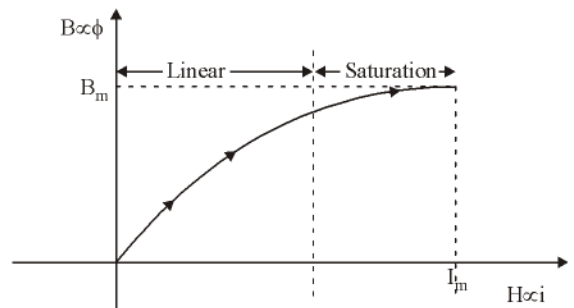

The equation  $\phi = \frac{f}{Rl}$  is developed on basis of the analogy of electrical circuit (force voltage analogy) shown below :

$$\text{Current} = \frac{\text{EMF}}{\text{Resistance}}$$

$$\Rightarrow i = \frac{e}{R}$$

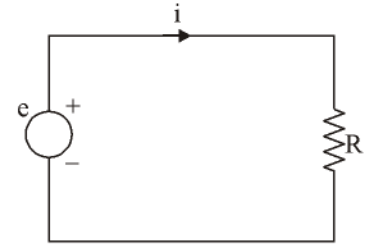

Where resistance  $R = \frac{l}{\sigma A} \left( R = \frac{l}{G} = \frac{l}{\sigma A / l} = \frac{l}{\sigma A} \right)$

$l$  &  $A$  are the length & area of cross-section while  $\sigma$  is the conductivity of material.

$$\text{Flux} = \frac{\text{mmf}}{\text{Reluctance}}$$

$$\Rightarrow \phi = \frac{f}{Rl}$$

**Note :** For high permeability material e.g. Iron,  $\mu_r$  is high &  $Rl$  is low it is said to be magnetic conductor or magnetic material. For low permeability material  $\mu_r \approx 1$  e.g. Cu etc.  $Rl$  is high so it is said to be non-magnetic material or magnetic insulator.

After  $\frac{T}{4}$  i.e.  $\frac{T}{4} < t < \frac{T}{2}$  where  $i$  decreases from  $I_m$ ,  $B$  also decreases but not in the same manner.

At  $t = \frac{T}{2}$ ,  $i = 0$  but  $B = B_r \neq 0$  i.e. some residual magnetism is left.

$B_r$  = Retentivity or Residual flux density.

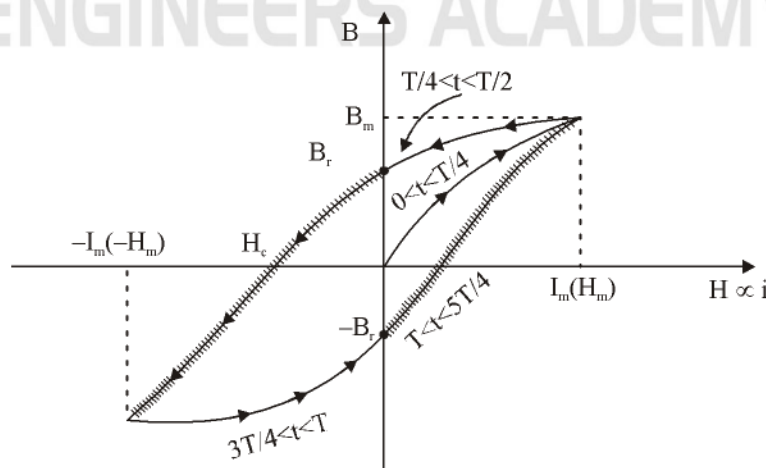

After  $\frac{T}{2}$  i.e.  $\frac{T}{2} < t < \frac{3T}{4}$  the direction of current  $i$  (&  $H$ ) gets reversed so magnetization is going on decreasing

and at a particular value of current say  $I_c$  (&  $H_c = \frac{NI_c}{l}$ )  $B$  becomes zero i.e. residual magnetism is lost due to  $H_c$ .

$H_c$  = Coercivity or Coercive force

As  $i$  increases further (in -ve direction)  $B$  gets reversed & becomes max at  $t = \frac{3T}{4}$ .

$\Rightarrow P_h \propto B_m^x f$   $B_m$  = Maximum flux density (Wb/m<sup>2</sup>)

$$P_h = K_h B_m^x f$$

Where  $x$  = Steinmetz constant ( $x = 1.6$ ),  $K_h$  = Hysteresis coefficient

According to B-H loop we categorize magnetic material broadly into two categories

### Hard Magnetic Material

- Wider B-H loop
- $B_r, H_c$  (Both high)
- Hysteresis loss Higher
- Suitable for d.c applications & permanent magnet etc.

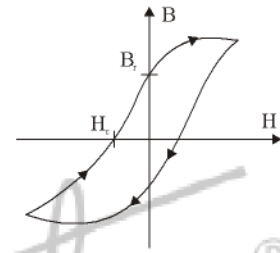

### Soft Magnetic Material

- Narrow B-H loop
- $B_r, H_c$  (both low)
- Hysteresis loss small
- Used for a.c applications e.g. Transformer, AC machines.

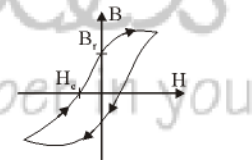

Let us neglect hysteresis & saturation, the B-H loop will be linear (as in case of air)

According to B-H loop

$$B \propto H$$

$$B = \mu H$$

$\mu$  = Permeability of core

$$\mu = \mu_0 \mu_r$$

$\mu_0$  = Absolute Permeability

$\mu_r$  = Relative Permeability

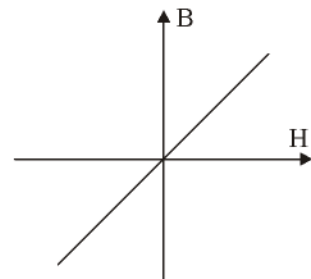

For linear magnetic circuit

$$\phi \propto I$$

$$\phi = \frac{\text{mmf}}{\text{Reluctance}} = \frac{f}{R/l}$$

$$\phi = BA \left( \because B = \frac{\mu NI}{l} \right)$$

$$\phi = \frac{\mu NI}{l} \cdot A$$

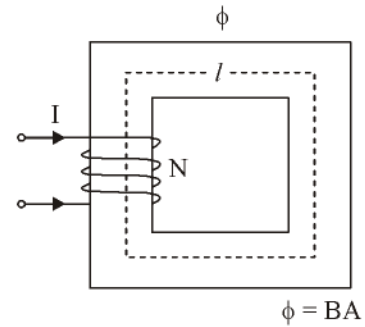

$$\phi = \frac{NI}{(l/\mu A)} = \frac{\text{mmf}}{\text{Reluctance}}$$

$l = \text{mean length of the core}$

$$\text{Reluctance} = \frac{l}{\mu A}$$

$$\phi = \frac{\mu NIA}{l}$$

Flux linkage

$$\psi = N\phi$$

$$N\phi \propto I$$

$$N\phi = LI$$

Inductance

$$L = \frac{N\phi}{I} \text{ i.e. flux linkage per unit current.}$$

$$L = \frac{N\phi}{I} = \frac{N}{I} \left( \frac{\mu NIA}{l} \right)$$

$$L = \frac{\mu N^2 A}{l}$$

$\Rightarrow$

$$L = \frac{N^2}{(l/\mu A)} = \frac{N^2}{R/l}$$

$$R/l = \text{Reluctance}$$

$\therefore$

$$\boxed{L \propto \frac{1}{R/l}}$$

Air gap length =  $l_g$

$R/l_i = \text{Reluctance of iron path}$

$R/l_g = \text{Reluctance of air path}$

Total Reluctance in the path of flux,  $\phi$

$$R_l = R_l' + R_l''$$

For iron path

$$R_l' = \frac{l_i}{\mu_0 \mu_r A}$$

$\mu_r \rightarrow$  Relative Permeability of iron.

For airgap,

$$R_l'' = \frac{l_g}{\mu_0 A}, \text{ As } (\mu_r = 1) \text{ for air}$$

As Permeability of iron is much greater than permeability of air ( $\mu_r = 1$ )

i.e.  $\mu_r \gg 1$

So, there fore we can say Reluctance of air gap will be more.

i.e.  $R_l'' \gg R_l'$

i.e. Total reluctance  $R_l \approx R_l''$  (air gap reluctance).

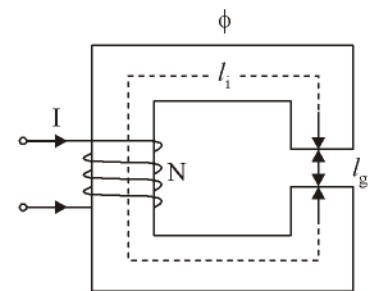

## 1.4 EDDY CURRENTS

If an iron piece is lying in the magnetic field, the flux linking  $\phi = BA \cos \theta$ , so  $\phi$  can be changed if either B, A or  $\theta$  changes.

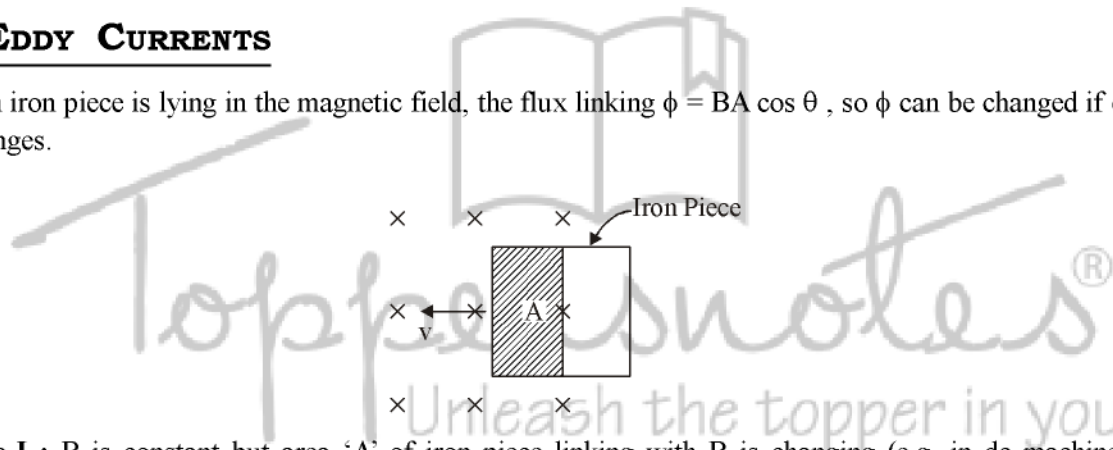

**Case-I :** B is constant but area 'A' of iron piece linking with B is changing (e.g. in dc machines) i.e.  $f = BA$  also changing with time.

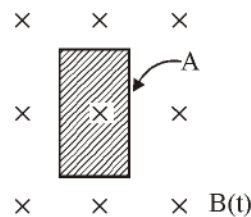

**Case-II :** Iron piece is stationary but B is changing w.r.t time (e.g. transformers), so  $\phi = BA$  is changing w.r.t time.

As flux linking  $\phi(t)$  is changing (in both the cases) there is induced emf in the iron piece i.e.

$$e \propto - \frac{d\phi}{dt}$$

Due to the induced emfs, there are induced currents in the iron i.e. eddy currents  $i_e$

$$i_e = \frac{e}{R_e}$$

Where  $R_e$  is the resistance in the path of eddy currents i.e. resistance of iron.

Eddy current loss i.e. power loss due to eddy currents

$$P_e = i_e^2 R_e = \frac{e^2}{R_e}$$

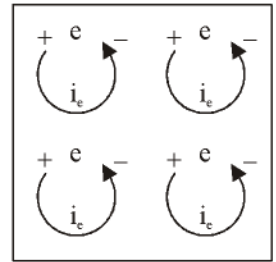

As 'e' is independent of  $R_e$

$$\Rightarrow P_e \propto \frac{1}{R_e}$$

So  $P_e$  can be reduced by increasing  $R_e$  i.e. using high resistivity iron.

$R_e$  can also be increased if instead of thick iron, laminated iron is used i.e. thin layers of iron pieces are separated by very thin layers of insulation.

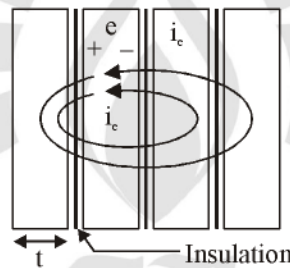

As resistance is introduced in the path of eddy currents so resistance  $R_e$  increases & hence power loss decreases.

Where 't' is thickness of lamination.

Consider the laminated iron core of transformer

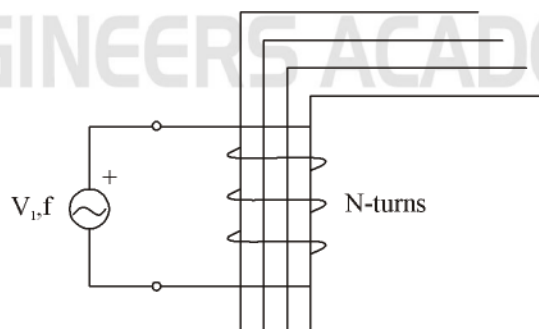

The eddy current losses are

$$P_e \propto \frac{\pi^2 B_m^2 f^2 t^2}{\rho_e \beta}$$

Where  $B_m$  is peak flux density in the core  
 $f$  is frequency  
 $t$  is thickness of lamination  
 $\rho_e$  is resistivity of iron core  
 $\beta$  is constant (depending upon the shape & size of lamination).  
 $P_e$  can also be reduced by using high resistance of iron core.

$$P_e \propto B_m^2 f^2 t^2$$

or  $P_e \propto B_m^2 f^2$

$\Rightarrow P_e = K_e B_m^2 f^2$

Where  $K_e$  is constant

The combination of hysteresis loss  $P_h$  & eddy current loss  $P_e$  is said to be iron loss.

$$P_i = P_h + P_e = K_h B_m^{1.6} f + K_e B_m^2 f^2$$

## 1.5 TRANSFORMER EQUATION

**Primary :** Where source is connected.

**Secondary :** Where load is connected.

**At No load.** Due to magnetising current  $I_m$  magnetising flux  $\phi_m$  is produced.

Let  $\phi_m = \phi_{\max} \sin \omega t$

Induced emf in Primary and secondary is  $e_1$  &  $e_2$

$$e_1 = \frac{-N_1 d\phi_m}{dt}, e_2 = \frac{-N_2 d\phi_m}{dt}$$

$$e_1 = -N_1 \frac{d}{dt} (\phi_{\max} \sin \omega t)$$

$$e_1 = -N_1 \omega \phi_{\max} \cos \omega t$$

$$e_1 = -N_1 \omega \phi_{\max} \sin(90 - \omega t),$$

As  $e_1 = N_1 \omega \phi_{\max} \sin(\omega t - 90^\circ)$

Peak emf  $E_m = N_1 \omega \phi_{\max}$

We can say induced emf  $\bar{E}$  lags behind the corresponding flux  $\phi_m$  by  $90^\circ$

$$e_i = N_1 \omega \phi_{\max} \sin(\omega t - 90^\circ)$$

$$e_i = E_m \sin(\omega t - 90^\circ)$$

Peak emf  $E_m = N_1 \omega \phi_{\max}$   
 $= N_1 (2\pi f) \phi_{\max} = 2\pi f N_1 \phi_{\max}$

Let r.m.s value of  $E_m$  is  $E_1$   $E_1 = \frac{E_m}{\sqrt{2}} = \sqrt{2} \pi f N_1 \phi_{\max}$

Similarly

$$E_2 = \sqrt{2\pi N_2 f \phi_{\max}}$$

$$\frac{E_2}{E_1} = \frac{N_2}{N_1}$$

$$\frac{N_2}{N_1} = K$$

K = Transformation ratio

As

$$V_1 \approx E_1$$

$$V_1 \approx \sqrt{2\pi f N_1 \phi_{\max}}$$

$$\phi_{\max} = \frac{1}{\sqrt{2\pi N_1}} \frac{V_1}{f}$$

$$\phi_{\max} = \frac{1}{\sqrt{2\pi N_1}} \left( \frac{V_1}{f} \right)$$

$$\phi_{\max} \propto \frac{V_1}{f}$$

At Load

$$\phi_{\max}$$

= constant

$$\phi_m = \frac{N_1 I_m}{R/l} \text{ \& Secondary flux } \phi_2 = \frac{N_2 I_2}{R/l}$$

According to Lenz's law the flux  $\phi_2$  of current  $I_2$  will oppose  $\phi_m$ .

**Lenz's law** : The induced current flows in such a direction so as to oppose very cause of its production.

So net flux in core =  $\phi_m - \phi_2$

Due to flux  $\phi_2$  net flux in the core decreased,  $(\phi_m - \phi_2)$

However

$$\phi_m \propto \frac{V_1}{f} = \text{constant,}$$

That's why to maintain flux  $\phi_m$  constant the primary winding produces additional flux  $\phi'_2$ , so it takes additional current  $I'_2$

Secondary flux

$$\phi_2 = \frac{N_2 I_2}{R/l}$$

Additional flux by Primary

$$\phi'_2 = \frac{N_1 I'_2}{R/l}$$

$\therefore$

$$\phi'_2 = \frac{N_1 I'_2}{R/l} = \frac{N_1 I_2}{R/l}$$

$$N_1 I'_2 = N_2 I_2$$

Primary Current

$$\bar{I}_1 = \bar{I}_m + \bar{I}'_2$$

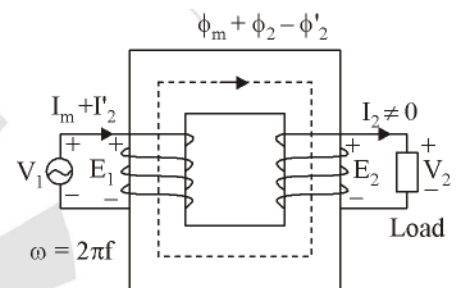

As  $\bar{I}_m \ll \bar{I}'_2$

$$I_1 \approx I'_2$$

so  $N_1 I_1 \approx N_2 I_2$

This equation is valid only when magnetising current is negligible.

**Example 1 (a) : Draw the phasor diagram of primary side of a transformer with lagging (R – L) load.**

**Note :**  $E_1 \approx V_1$

$$V_1 = \bar{E}_1 + \bar{I}_1 (R_1 + jX_1)$$

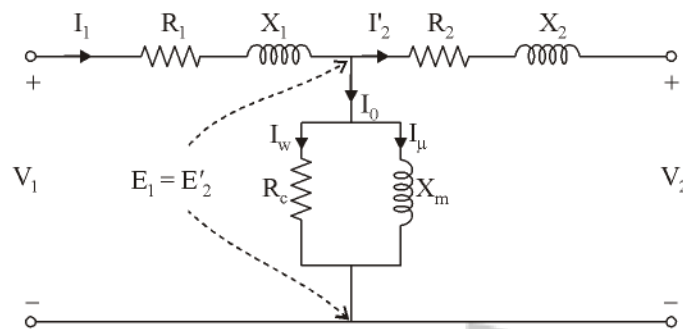

**Solution :**

Let  $\bar{I}_1$  at lag pf  $\cos \phi$

$\bar{I}_1$  lags  $\bar{E}_1$  by angle  $\phi$

At lagging

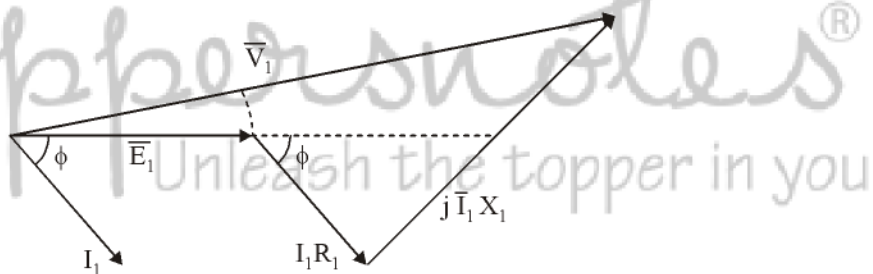

Phasor diagram of primary side with (R – L) load

So  $E_1 \leq V_1$  (As leakage impedance  $R_1, X_1$  very low)

**Example 1 (b) : Draw the phasor diagram of primary side of a transformer with leading (R – C) load.**

$\bar{I}_1$  leads  $\bar{E}_1$  by angle  $\phi$

$$E_1 \geq V_1$$

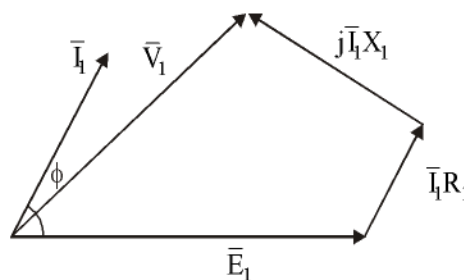

**Example 2 :** The useful flux of a Transformer is 1Wb. when it is loaded at 0.8pf lag, then its mutual flux

(a) May decrease to 0.8Wb

(b) May increase to 1.01Wb

(c) Remains constant

(d) May decrease to 0.99Wb

**Ans.(d)**

**Solution:** At no load ( $I = 0$ )

$$V_1 \approx E_1$$

$$E_1 = \sqrt{2}\pi f N_1 \phi_m$$

$$\phi_m = \frac{1}{\sqrt{2}\pi N_1} \frac{E_1}{f}$$

At no load

$$E_1 \approx V_1$$

$$\phi_{m0} = \frac{1}{\sqrt{2}N_1\pi} \left( \frac{V_1}{f} \right) = 1\text{Wb}$$

At lag pf  $E_1$  decreases slightly ie  $E_1 \leq V_1$

So

$$\phi'_m = \frac{1}{\sqrt{2}\pi N_1} \left( \frac{E_1}{f} \right) \leq \phi_{m0}$$

So magnetising flux decreases slightly ie approx 0.99 Wb

### 1.5.1 Equivalent Circuit of Transformer

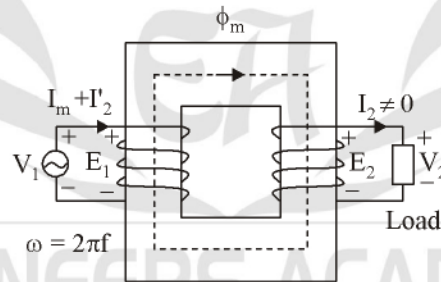

$\phi_m =$  magnetising flux or useful flux

