



# **UPSC – CSAT**

## **Civil Services Exam**

**Union Public Service Commission**

**Part - 1**

**Mental Ability**



# UPSC – CSAT (ENGLISH)

## CONTENTS

| <b>MENTAL ABILITY</b> |  |     |
|-----------------------|--|-----|
| 1.                    | <b>Analogy</b>                                 | 1   |
| 2.                    | <b>Classification</b>                          | 12  |
| 3.                    | <b>Series Test</b>                             | 17  |
| 4.                    | <b>Inserting the Missing Character/ Number</b> | 27  |
| 5.                    | <b>Blood Relation</b>                          | 33  |
| 6.                    | <b>Distance &amp; Direction</b>                | 43  |
| 7.                    | <b>Seating Arrangement</b>                     | 55  |
| 8.                    | <b>Venn Diagram</b>                            | 67  |
| 9.                    | <b>Coding – Decoding</b>                       | 79  |
| 10.                   | <b>Puzzle Test</b>                             | 90  |
| 11.                   | <b>Cube &amp; Dice</b>                         | 110 |
| 12.                   | <b>Number Ranking</b>                          | 118 |
| 13.                   | <b>Decision Making</b>                         | 127 |
| 14.                   | <b>Statement and Conclusion</b>                | 135 |
| 15.                   | <b>Syllogism</b>                               | 141 |
| 16.                   | <b>Statement and Argument</b>                  | 152 |

|     |  |     |
|-----|--|-----|
| 17. | <b>Statement and Assumptions</b>       | 160 |
| 18. | <b>Statements and Course of Action</b> | 167 |
| 19. | <b>Cause and Effect</b>                | 175 |

## ANALOGY

Similarity or similarity is the relation or similarity of any object, word, letter, number to any other object, word, letter, number with quality, form, shape, type, character, etc.

Generally, these types of questions are asked under analogy.

### Type 1 - Hindi word analogy

Under this, considering the relation of Hindi words given in the questions asked, one has to find such a word from the given answer options, whose relation can be established with the given words or with the third word.

(i) Finding similar words: - Considering the relation of two words given in the questions asked under this, one has to find such word from the answer options, whose relation is established with the given third word.

**Ex.1** Select the related word from the given alternatives.

River : Stream :: Ocean : ?

- (a) Current                      (b) Pond  
(c) Dam                          (d) Sea

**Ans. (a)**

**Sol.** Just as a stream originates from the water of a river, in the same way a current arises from the water of the ocean.

**Ex.2** The way Colombo is related to Sri Lanka, in the same way Kathmandu is related to?

- (a) Tibet                          (b) India  
(c) Bhutan                        (d) Nepal

**Ans. (d)**

**Sol.** Just as Colombo is the capital of Sri Lanka, in the same way, Kathmandu is the capital of Nepal.

(ii) Finding the identical pair :- In the questions that come under this, two words are given, which are related to each other in some way. Exactly the same type of relation is also in any one of the options given below.

**Ex.3** Select the related word pair from the given alternatives.

Preamble : Constitution :: ? : ?

- (a) Word : dictionary  
(b) Theme : Magazine  
(c) Explanation : Poem  
(d) Introduction : Book

**Ans. (d)**

**Sol.** Just as there is a preamble of the constitution, in the same way there is a preamble of the book.

(iii) **Choosing similar words and special classes for similar words -**

Some words are given in the questions coming under it. You have to choose a word from the given alternatives which is exactly same as the word given in the beginning and find the word which shows the particularity among the words given in the question.

**Ex.4** Who is the same as - Earthquake, cyclone, volcanic eruption

- (a) Global heat  
(b) Flood  
(c) Accidents  
(d) Nuclear explosion

**Ans. (b)**

**Sol.** Just as earthquakes, cyclones and volcanic eruptions are natural disasters. Similarly, floods are also a natural disaster.

**Ex.5** Given below three words, which have some common features, select the correct option.

Snake, lizard, crocodile

- (a) Reptiles            (b) Mammals  
(c) Omnivores        (d) Deer

**Ans. (a)**

**Sol.** Snake, Lizard and Crocodile are all three reptiles.

**Ex.6** Find the alternative which has the same relation as in all the three words given below.

King, Queen, Palace

- (a) Pigeon, bird, dispensary  
(b) Goat, goat, fort  
(c) Bumblebee, spider, water  
(d) Lion, lioness, cave

**Ans. (d)**

**Sol.** Just as both the king and queen reside together in the palace, in the same way both the lion and the lioness reside together in the cave.

**(iv)** Double Symmetry:- Under this, two words are given on the left and right of the symbol (::) in the question. Each word is missing in both the words.

The missing word has to be found from the options given below.

**Ex.7** In the following question, find out the missing word from the alternative given below

A : Ugly :: Peace : B

- (a) A – Beautiful, B – War  
(b) A – Friendship, B – Noise  
(c) A – Honesty, B – Treaty  
(d) A – Number, B – Strike

**Ans. (a)**

**Sol.** Just as, beautiful and ugly are opposite words of each other. Similarly, peace and war are also opposite words to each other.

### Type - 2 English Alphabets Analogy

The questions under this are based on letters or letter groups of the English alphabet. After knowing the relationship of the first two letter-groups given in these questions, on this basis, the correct answer for the third letter-group has to be found from the options.

**Vowels and Consonants of English Letters:-**

Vowel Letters – A, E, I, O, U

Consonant Letter – B, C, D, F, G, H, J, K, L, M, N, P, Q, R, S, T, V, W, X, Y, Z

**English alphabets their corresponding numbers :-**

|                   |   |   |   |   |   |   |   |   |   |    |    |    |    |
|-------------------|---|---|---|---|---|---|---|---|---|----|----|----|----|
| English Alphabet  | A | B | C | D | E | F | G | H | I | J  | K  | L  | M  |
| Corresponding No. | 1 | 2 | 3 | 4 | 5 | 6 | 7 | 8 | 9 | 10 | 11 | 12 | 13 |

**Ex.8** CHAIR : RIAHC :: TABLE : ?

- (a) BLAET                      (b) ETABL  
(c) LETAB                      (d) ELBAT

**Ans. (d)**

**Sol.** Like,

CHAIR                      →                      RIAHC

Similarly,

TABLE                      →                      ELBAT

**Ex.9** HORSE : SERHO :: CURSE : ?

- (a) RCUES                      (b) SECRU  
(c) SERCU                      (d) ERCUS

**Ans. (c)**

**Sol.**

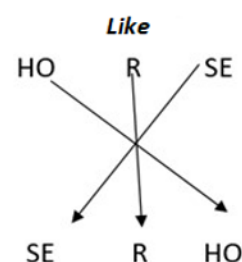

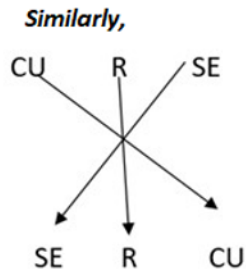

**Ex.10** EGH : IJK :: NPQ : ?

- (a) PRS                      (b) RSU  
(c) RTU                      (d) RST

**Ans. (d)**

**Sol.**

Like,

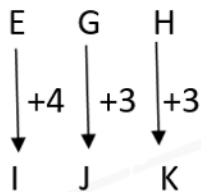

Similarly,

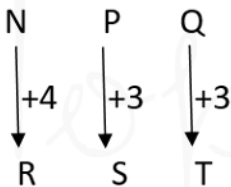

### Type - 3 English Word Analogy

The questions under this are based on English words. After finding the relation of the first two words given in these questions, we find out the correct answer for the third word from the options on the same basis.

#### (i) Finding Related Words

**Ex.11** In the following question, select the option which is related to the third word in the same way as the second term is related to the first term.

Shallow : Profound :: Synonym : ?

- (a) Context                      (b) Antonym  
(c) Meaning                      (d) Content

**Ans. (b)**

**Sol.** Just as the opposite word of Shallow is Profound, similarly, the opposite word of Synonym is Antonym.

#### (ii) To find the word pair similar to the word pair :-

**Ex.12** Which of the following pair of words shows the same relation. What kind of relationship is there between Fan : Heat ?

- (a) Water : Drink  
(b) Food : Hunger  
(c) Light : Night  
(d) Air : Breath

**Ans. (b)**

**Sol.** When there is heat, then the fan is turned on, in the same way food is done when there is hunger.

### Type - 4 - Number Analogy

In the questions that come under this, questions are asked based on the order of numbers, the order of the squares of the numbers, the sequence of prime numbers, etc. In other words, the questions asked under it are based on mathematical operations.

**Ex.13** Select the option, which is related to the third term in the same way as the second term is related to the first term.

23 69 : 27 : ?

- (a) 91                              (b) 73  
(c) 81                              (d) 89

**Ans. (c)**

**Sol.** Like  $23 \times 3 = 69$   
Similarly,  $27 \times 3 = 81$

**Ex.14** Select the related number from the given alternatives.

8 : 32 :: 6 : ?

- (a) 31                              (b) 22  
(c) 18                              (d) 21

**Ans. (c)**

**Sol.** Like  $8^2 = 64$   
 $64 \div 2 = 32$   
Similarly,  $6^2 = 36$   
 $36 \div 2 = 18$

**Ex.15** From the given alternatives, find the one which is similar to  $10 : 13 :: 16$ .

- (a)  $8 : 10 : 15$
- (b)  $13 : 16 : 19$
- (c)  $23 : 29 : 23$
- (d)  $10 : 16 : 23$

**Ans. (b)**

**Sol.** Like,  $10 : 13 :: 16$   
 $+3 +3$   
Similarly,  $13 + 16 + 19$   
 $+3 +3$

### (Analogy or Similarity)

#### Type – I

**Directions - Find out the related words from the alternatives given below.**

1. Virus : Chickenpox :: Bacteria : ?  
(a) Chickenpox  
(b) Typhoid  
(c) Malaria  
(d) Sleeping Disease

**Ans. (b)**

**Explanation:**

Smallpox is spread by virus. Similarly, typhoid is caused by bacteria (Bacteria name: Salmonella Typhi).

2. Book : Shelf :: Clothes : ?  
(a) Hanger (b) Cupboard  
(c) Wardrobe (d) Bureau

**Ans. (c)**

**Explanation –**

Books are kept systematically on the shelf. Similarly, clothes are kept in the wardrobe.

3. Gramophone : Record :: Video : ?

- (a) T.V. (b) Recording
- (c) Cassette (d) Camera

**Ans. (c)**

**Explanation –**

Gramophone (record) is a thin circular plastic object on which voice, especially music, is recorded.

Video is recorded on cassette or magnetic tape.

4. Axe : Rip :: Path : ?

- (a) Shear (b) Pull
- (c) Ploughing (d) Knitting

**Ans. (d)**

**Explanation –**

The axe is used to cut or tear wood. In the same way something is knitted with needle.

5. Bird : Feather :: Fish : ?

- (a) Gills (b) Scales
- (c) Tail (d) Pisces

**Ans. (2)**

**Explanation –**

The body of a bird is covered with feathers, similarly, the body of a fish is covered with scales.

6. Movement : Required :: Effort : ?

- (a) Personality (b) Motivation
- (c) Success (d) Probability

**Ans. (c)**

**Explanation –**

When the need arises, the person becomes agitated. Similarly, to achieve success, one has to do efforts.

#### Type – II

**Direction - Find out the related number from the alternatives given below.**

7.  $85 : 42 :: 139 : ?$

- (a) 68 (b) 69
- (c) 70 (d) 67

**Ans. (b)**

**Explanation –**

$$85 - 1 = 84, 84 \div 2 = 42$$

$$139 - 1 = 138, 138 \div 2 = 69$$

8. 8 : 28 :: 27 : ?

- (a) 8 (b) 28  
(c) 64 (d) 65

**Ans. (d)**

**Explanation –**

$$(4) (2)^3 \times 2 \times 2 \times 2 = 8$$

$$28 = (3)^3 + 1 = 3 \times 3 \times 3 + 1 = 28$$

$$(3)^3 = 3 \times 3 \times 3 = 27$$

$$\therefore ? = 4 \times 4 \times 4 + 1 = 65$$

9. 8 : 56 :: 9 : ?

- (a) 10 (b) 63  
(c) 7 (d) 9

**Ans. (b)**

**Explanation –**

The relationship is as follows =  $x - 7$

$$8 \times 7 = 56$$

Similarly,

$$9 \times 7 = 63$$

10. 8 : 512 :: 9 : ?

- (a) 781 (b) 792  
(c) 729 (d) 728

**Ans. (c)**

**Explanation –**

$$8 : (8)^3 = 512$$

Similarly,

$$9 : (9)^3 = 729$$

11. 21 : 3 :: 574 : ?

- (a) 113 (b) 23  
(c) 97 (d) 82

**Ans. (d)**

**Explanation –**

$$\frac{21}{7} = 3$$

$$\text{Similarly, } \frac{574}{7} = 82$$

12. 100 : 121 :: 36 : ?

- (a) 64 (b) 49  
(c) 25 (d) 16

**Ans. (b)**

**Explanation –**

$$10 \times 10 = 100$$

$$11 \times 11 = 121$$

$$6 \times 6 = 36$$

Similarly,

$$7 \times 7 = 49$$

### Type – III

**Directions - Find out the related letters from the alternatives given below.**

13. AGMS : CIOU :: DJPV : ?

- (1) BHNY (b) STUV  
(c) FLRX (d) MNOP

**Ans. (c)**

**Explanation –**

Like,

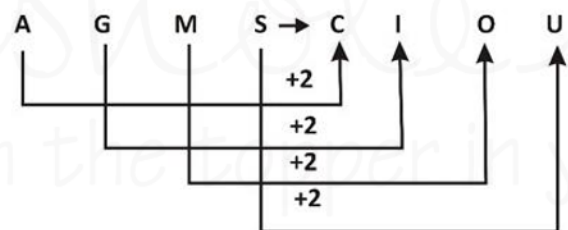

Similarly,

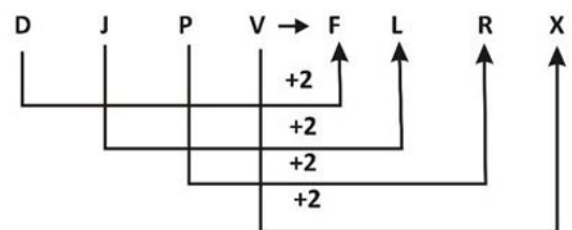

14. CAT : DDY :: BIG : ?

- (a) CLL (b) CLM  
(c) CML (d) CEP

**Ans. (a)**

**Explanation –**

Like,

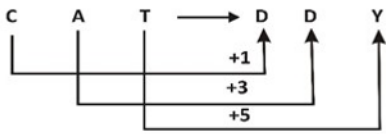

Similarly

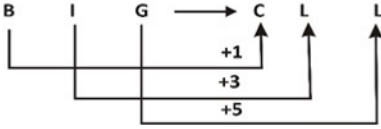

15. KMF : LLH :: RMS : ?  
 (a) SLR (b) SLU  
 (c) SSU (d) SUS

Ans. (b)

Explanation -

Like,

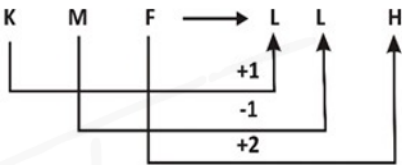

Similarly,

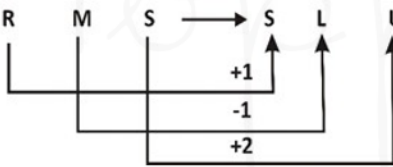

16. CEGI : RTVX :: IKMO : ?  
 (a) JKLNP (b) LNPR  
 (c) MNPQ (d) DFHI

Ans. (b)

Explanation -

Like,

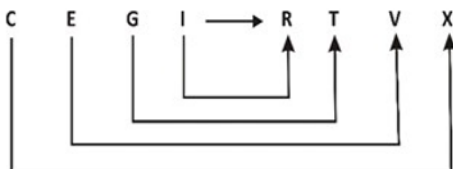

Similarly,

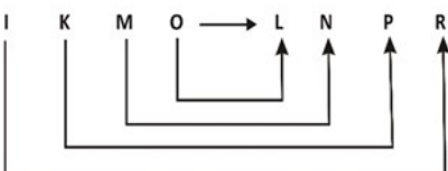

17. ABCD : QRST :: BACD : ?  
 (a) RQST (b) STQR  
 (c) QRST (d) RSTQ

Ans. (a)

Explanation -

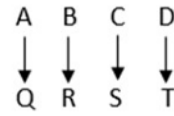

Therefore,

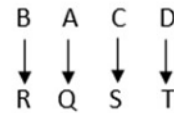

18. ACE : BDF :: MAQ : ?  
 (a) BMW (b) NQP  
 (c) NPR (d) BEF

Ans. (c)

Explanation -

Like,

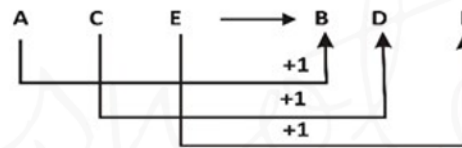

Similarly,

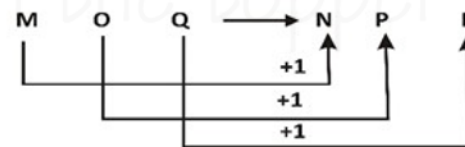

19. BFG : EIJ :: RVW : ?  
 (a) UWY (b) UYZ  
 (c) SWX (d) QUV

Ans. (b)

Explanation -

Like,

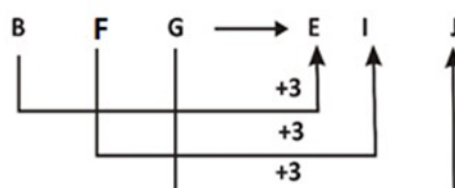

Similarly,

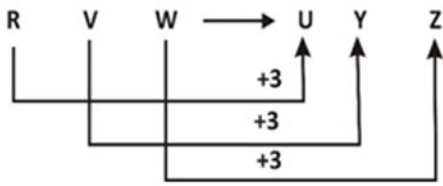

20. STAR : TSRA :: ROSE : ?

- (a) ORSE                      (b) ORES  
(c) ESOR                      (d) SORE

Ans. (b)

Explanation –

Like,

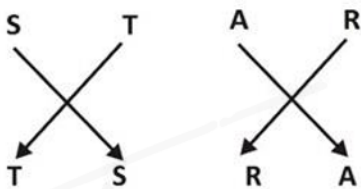

Similarly,

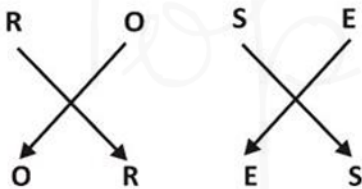

21. ADIP : DGLS :: BEJQ : ?

- (a) CGLS                      (b) EHMT  
(c) EJQU                      (d) FINU

Ans. (b)

Explanation –

Like,

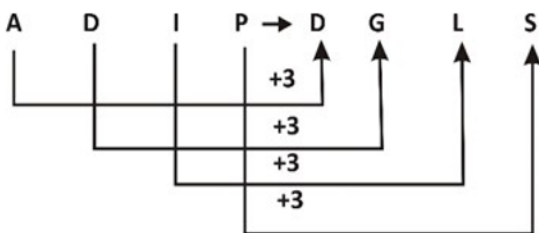

Similarly,

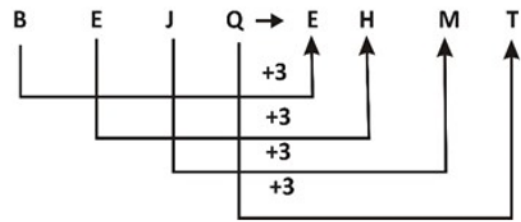

22. EI : AE :: UO : ?

- (a) PK                              (b) QJ  
(c) PJ                              (d) QK

Ans. (d)

Explanation –

Like,

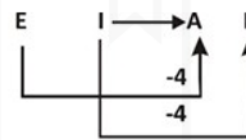

Similarly,

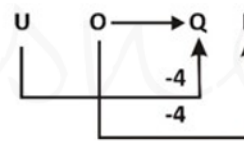

23. GHP : FFM :: PIC : ?

- (a) OGZ                              (b) OHZ  
(c) NGA                              (d) NHA

Ans. (a)

Explanation –

Like,

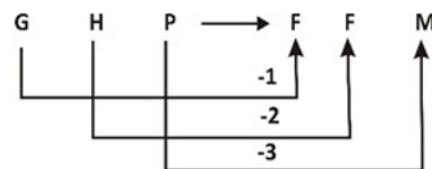

Similarly,

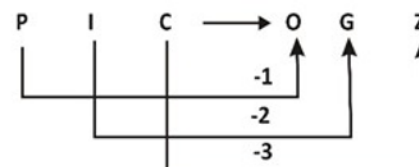

24. AIR : ZKO :: CAP : ?  
 (a) ACM (b) ABN  
 (c) BCM (d) BBN

Ans. (c)

Explanation –

Like,

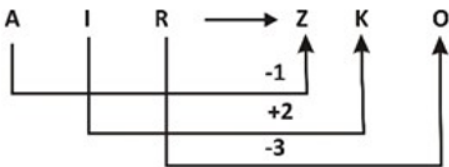

Similarly,

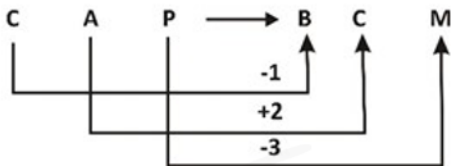

25. NU : MF :: EH : ?

- (a) IR (b) VS  
 (c) GT (d) DW

Ans. (b)

Explanation –

Like,



*These are all combinations of opposite characters.*

26. BAND : DCPF :: PUSY : ?

- (a) GVTZ (b) HWTZ  
 (c) GVUA (d) HWUA

Ans. (d)

Explanation –

Like,

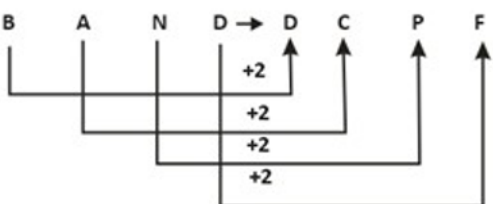

Like,

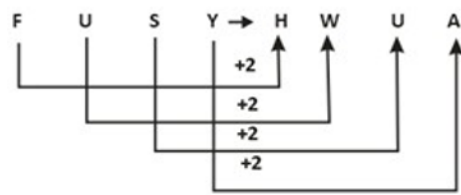

27. FAM : HBO :: LMP : ?

- (a) MOR (b) NOR  
 (c) NNR (d) MNR

Ans. (c)

Explanation –

Like,

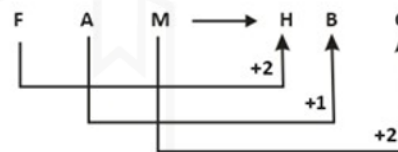

Like,

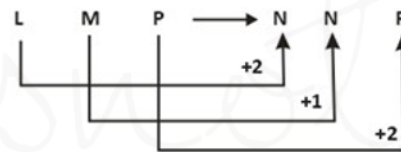

28. AB : CD :: WX : ?

- (a) AZ (b) YZ  
 (c) XM (d) PQ

Ans. (b)

Explanation –

Like,

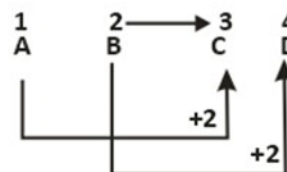

Similarly,

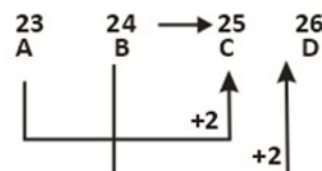

29. OPQ : RST :: ABC : ?

- (a) BCA                      (b) DMN  
(c) DEF                      (d) ABD

Ans. (c)

Explanation –

Like,

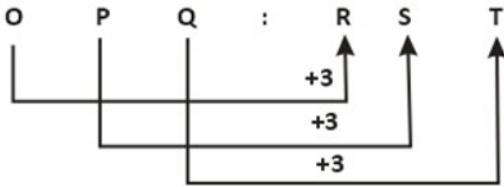

Similarly,

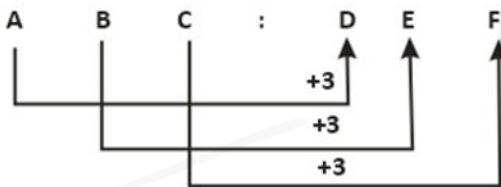

30. Select the option whose letters share the same relationship as the pairs of the given letters.

JT : NX

- (a) TP : XT                      (b) RK : VG  
(c) GS : KU                      (d) LD : PG

Ans. (a)

Explanation –

Like,

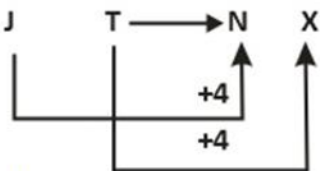

Like

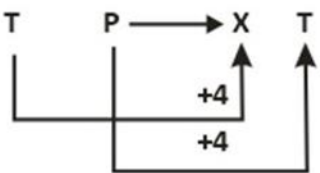

## Analogy Practice

**Q.1.** If CPI : DMK, then who among the following will be BJP?

- (a) GC                                      (b) CGR  
 (c) CRG                                      (d) CSF

**Ans. (b)**

**Explanation –**

Just as,

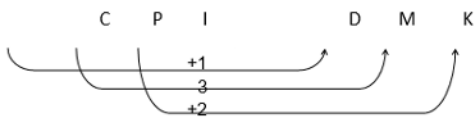

Similarly,

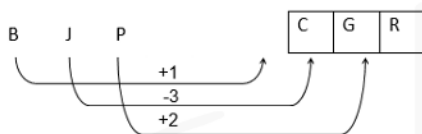

**Q.2.** Which of the following pairs have the same relation as between JL : WZ?

- (a) AC : R                                      (b) AB : PW  
 (c) PR : LM                                      (d) TU : WX

**Ans. (a)**

**Explanation**

Just as,

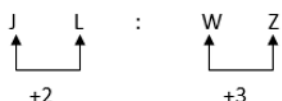

Similarly,

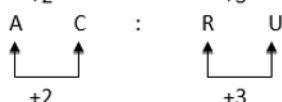

Hence, option (a) with the correct sequence is the correct Ans..

**Q.3.** 'Doctor' is related to 'Nurse' in the same way as Police Inspector is related to?

- (a) Thief                                      (b) Constable  
 (c) Pistol                                      (d) Jail

**Ans. (b)**

**Explanation -** Just like a nurse is an assistant to a doctor. Similarly, the constable is an assistant to the 'Inspector'.

**Q.4.** The relation "Optimistic : Pessimistic" is best explained in which of the following?

- (a) Difficult: Impossible  
 (b) Export: Import  
 (c) Reading: Playing  
 (d) Tolerable: Detestable

**Ans. (b)**

**Explanation –** Optimistic : Pessimistic is a combination of two antonyms. Similarly, option (b) shows such relationship.

**Directions -** In the following question three words are given and alternative words are given below them. Out of these four alternative words, one word represents the class of the above three words. Find that one alternative expression

**Q.5.** Hammer, Saw, Sand

- (a) Pen                                      (b) Screwdriver  
 (c) Fork                                      (d) Carpenter

**Ans. (b)**

**Explanation -** Screwdriver is also a tool like hammer, saw and sander.

**Directions -** In the following question, two words are given, which are related to each other in a similar way, in any one of the alternatives given below, select that option.

**Q.6.** Australia : Continent : : ?

- (a) Engine : Train  
 (b) River : Coast  
 (c) Vikrant : Ship  
 (d) Yuri Gagarin : Space

**Ans. (c)**

**Explanation** - Just as 'Australia' is a 'continent', similarly 'Vikrant' is a 'ship' (aircraft-carrier).

**Q.7.** As 'Accident' is related to 'Caution', in the same way 'Sickness' is related to?

- (a) Bacteria
- (b) Pollution
- (c) Hygiene
- (d) Doctor
- (e) None of these

**Ans. (c)**

**Explanation** - As with caution, accidents do not happen. Similarly, cleanliness does not cause disease.

**Q.8.** Just as 'justice' is related to 'court'. Similarly, which of the following is related to 'School'?

- (a) Teacher
- (b) Student
- (c) Class
- (d) Education
- (e) None of these

**Ans. (D)**

**Explanation** - Just as justice is done in court. similarly, education takes place in school.

## Classification

Classification is the process of classifying any letter-group, word and number into a group based on their common quality, religion, shape-type, color, form, character and other properties.

**Ex.1** Select the a different word.

- (A) Apple                      (B) Grapes  
(C) Banana                    (D) Potato

**Ans. (D)**

**Sol.** Apple, Grapes, Banana is a fruit and Potato is a vegetable. Hence, potato is different from group.

**Ex.2** Choose a different word.

- (A) T.V  
(B) Cycle  
(C) Refrigerator  
(D) Washing Machine

**Ans. (B)**

**Sol.** All households are electronic equipment except cycle. Therefore the cycle is different from the group.

## Types of Questions

### Type 1 Choosing a different word

In this type of questions, some words are given as options, except one of which all the other words belong to a group, class or caste, while the last word of the rest of the other i.e. different group, caste or class.

Some of the major similarities of the words are as follows -

- (1) Equality of meaning
- (2) Functional similarity
- (3) Structural similarity
- (4) Numerical equality
- (5) Equality of space
- (6) Equality of terms
- (7) Equality of relation between the two
- (8) Technical Equivalence

**Ex.3** Select the odd word from the given alternatives ?

- (A) Bus                              (B) Car  
(C) Truck                            (D) Airplane

**Ans. (D)**

**Sol.** All other vehicles except airplanes are road-going vehicles, whereas airplane flies in the air.

**Ex.4** Choose a different word ?

- (A) CV Raman  
(B) Subhash Chandra Bose  
(C) Mahatma Gandhi  
(D) Bhagat Singh

**Ans. (A)**

**Sol.** Among the given persons, CV Raman was a scientist, while Subhash Chandra Bose, Mahatma Gandhi and Bhagat Singh were freedom fighters of India.

**Ex.5** Which of the following is an odd state ?

- (A) Chhattisgarh      (B) Uttarakhand  
(C) Jharkhand            (D) Gujrat

**Ans. (D)**

**Sol.** Gujrat is a coastal state while all others are landlocked states.

**Ex.6** Find out the different option?

- (A) Hear                              (B) Climb  
(C) Swim                              (D) Run

**Ans. (A)**

**Sol.** Apart from listening, all other physical activities are done by activities.

### Type 2 - Choosing a different word pair

In this type of question four/five pairs of words are given, out of which three/four words are alike in some way and in this way they form a group of their own while the rest One pair is different from the other.



**Sol.** Except the KLMN letter-group, all other letter-groups have a gap of two letters between the first and third position letters.

**Ex.15** Select a different letters-set from the given alternatives?

- (A) SPMJ                      (B) XURO  
(C) NKHE                      (D) ZWSP

**Ans. (D)**

**Sol.**

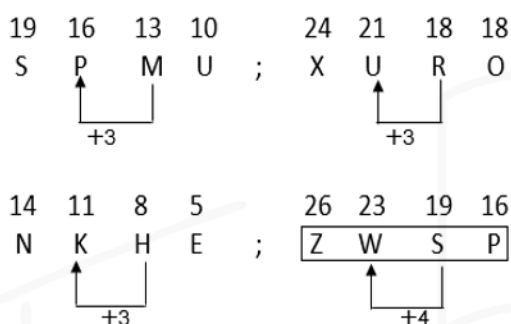

Except for the ZWSP letter-group, there is a gap of two letters between the second and third-position letters in all other letter-groups.

**(v) Classification on the basis of (semi-letter pair/group)-**

**Ex.16** Select the following letter-groups?

- (A) M - O                      (B) P - R  
(C) A - C                      (D) E - F

Ans. (D)

**Sol.**

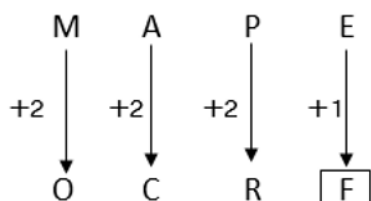

In all others except option (D), the second letter is obtained by adding 2 to the first letter.

**Ex.17** Find out the odd letter pair from the given alternatives?

- (A) AB : ZY                      (B) CD : XW  
(C) GH : TS                      (D) EF : UV

**Ans. (D)**

**Sol.**

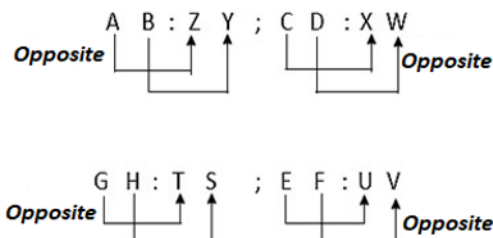

In the given pairs the letters are given opposite to each other, whereas it is not so in EF : UV. Therefore, it is different.

**Type - 4 Selecting a different Number/ Number group**

In this type of questions some group of numbers or numbers are given, out of which one digit/number has to be found, which does not show similarity with the others present in the group.

**Ex.18** Choose a different number ?

- (A) 1234                      (B) 2345  
(C) 3456                      (D) 5778

**Ans. (B)**

**Sol.** Except the number 2345, all other numbers are even numbers.

**(i) Classification based on equality of composite/prime numbers -**

- Those natural numbers, which are divisible by 1 or other numbers other than itself, are called composite numbers, such as - 4, 6, 8, 9, 14, 15
- Those natural numbers which are greater than 1 and which are divisible only by 1 or themselves are called prime numbers.  
Like - 2, 3, 5, 7, 11, 13, 17, 19, 23 etc.

**Ex.19** Which of the following numbers is different from the rest ?

- (A) 23                      (B) 51  
(C) 63                      (D) 15

**Ans. (A)**

**Sol.** The digit 23 is different because it is a prime number.

**Ex.20** Choose the different number from the following ?

- (A) 61                      (B) 51  
(C) 97                      (D) 89

**Ans. (B)**

**Sol.** Except 51, all others are prime numbers.

**(ii) Classification on the basis of equality of square/cube numbers-**

**Ex.21** Choose a different number?

- (A) 25                      (B) 50  
(C) 100                      (D) 10000

**Ans. (B)**

**Sol.** All numbers except the number 50 are square numbers.

**(iii) Classification on the basis of equality of divisibility and indivisibility of numbers-**

**Ex.22** Select the odd number from the following ?

- (A) 91                      (B) 84  
(C) 78                      (D) 26

**Ans. (B)**

**Sol.** Except 84, all others are divisible by 13.

**(iv) Classification based on similarity to the sum of the digits of a number -**

**Ex.23** Select the odd number?

- (A) 6023                      (B) 7202  
(C) 4025                      (D) 5061

**Ans. (D)**

**Sol.** Except for the number 5061, the sum of the digits in all the others is 11.

**(v) Classification on the basis of group of three numbers -**

**Ex.24** Select the different set of numbers from the given alternatives ?

- (A) (5, 16, 22)              (B) (6, 19, 25)  
(C) (4,13,17)              (D) (9,28,37)

**Ans. (A)**

**Sol.** As,

$$6, 6 \times 3 + 1 = 19, \quad 19 + 6 = 25$$

$$4, 4 \times 3 + 1 = 13, \quad 13 + 4 = 17$$

$$9, 9 \times 3 + 1 = 28, \quad 28 + 9 = 37$$

$$\text{But, } 5, 5 \times 3 + 1, 16 + 5 = 21 \neq 22$$

Hence, option (A) is different.

## Classification Practice

**Directions (Q. No. 1- 4) - Out of the following questions, three out of four are alike in some way or the other and thus form a group. Tell which one of these is different from the other three.**

- Q.1.** (a) Guitar (b) Sarangi  
(c) Flute (d) Veena

**Ans - (c)**

**Explanation** - Except 'flute' all other stringed instruments are.

- Q.2.** (a) 71, 17, 11, 5 (b) 71, 67, 7, 3  
(c) 37, 19, 15, 7 (d) 71, 13, 5, 3

**Ans-(c)**

**Explanation** - Except option (c), all other prime numbers are given in option whereas option (c) does not contain a number. So it is different from other options.

- Q.3.** (a) Peso (b) Phi  
(c) Delta (d) Gamma

**Ans. (a)**

**Explanation** - Except peso, all others are Greek letters.

- Q.4.** (a) Troubled (b) Truthful  
(c) Cunning /sly (d) Virtuous

**Ans-(c)**

**Explanation** - Except "sly" all others are positive words.

**Q5.** Which one of the following word pairs is not logically related?

- (a) Gold : Jewelry  
(b) Wood : Furniture  
(c) Pitcher : Earthen pot  
(d) Straws : Nest

**Ans. (c)**

**Explanation** - Except option (c) in all other options the second thing is formed from the first item, whereas in option (c) it is not so.

## Series

The series test series has to be studied carefully to find out whether this series is following the order/rule or not.

The questions asked under this test can be classified into the following categories.

1. Digit series
2. Alphabet series
3. Frequency Series of Digits/Characters

There are a few things to keep in mind while doing chain test.

- A. First try to play the whole chain.
- B. If the chain does not work, then we run it by laughing.
- C. At the very end run the alternate series

### 1. Digit series -

In this, a series of marks is given in the questions asked. This series is based on addition, subtraction, multiplication, division, square, square root, cube, cube root etc.

#### Type - (i) Finding the wrong term in the series.

In the series sequence, a wrong digit is added in place of the digit appearing at a particular place. For this, first of all it should be known that which term is not changing according to that rule, that is the wrong term.

**Ex.1 Which number is missing in the following number series?**

**76, 98, 126, 160, 200, 248, 298**

- (A) 248                      (B) 200  
(C) 160                      (D) 298

**Ans. (A)**

**Sol.** After observing the above series carefully, we find that the sixth term of the series is inappropriate

Because the number to be added to each term is 6 digits more than its first number.

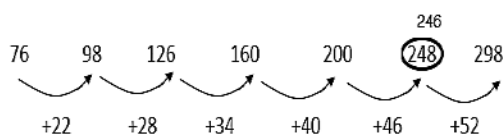

So instead of 248, there will be 246.

**Ex.2 Which number in the following series is such that it is inappropriate in the series?**

**5, 3, 6, 10, 9, 12, 17, 15, 18, 23**

- (A) 6                              (B) 9  
(C) 12                              (D) 10

**Ans. (D)**

**Sol.** After observing the above series carefully, we find that the series is decreasing and increasing in the order of -2, +3, +5, -2, +3, +5 .....

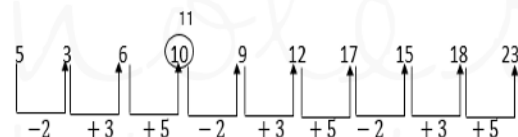

In the above series, 11 should come after the digit '6'. Hence the wrong number in the series is 10.

**Directions: Question (1-7) Find the missing number in the following series.**

**Q.1 56, 42, 30, 20, ?, 6**

- (A) 15                              (B) 12  
(C) 18                              (D) 14

**Ans. (B)**

**Explanation-**

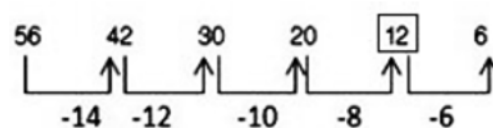

So, ? = 12