



# UPPSC

## Prelims

**Uttar Pradesh Public Service Commission**

**Volume – 3**

**Art & Culture**



# INDEX

| S No. | Chapter Title                             | Page No. |
|-------|---|----------|
| 1     | Indian Architecture                       | 1        |
| 2     | Temple Architecture                       | 9        |
| 3     | Indian Sculpture                          | 21       |
| 4     | Indian Paintings                          | 26       |
| 5     | Dance Forms in India                      | 33       |
| 6     | Music in India                            | 39       |
| 7     | Indian Religion and Philosophy            | 46       |
| 8     | Indian Literature and Language            | 53       |
| 9     | Theatre Forms and Puppetry in India       | 59       |
| 10    | Indian Handicrafts                        | 63       |
| 11    | Cultural Institutions in India and Awards | 70       |
| 12    | Martial Arts in India                     | 76       |
| 13    | UNESCO–World Heritage Sites in India      | 79       |
| 14    | Intangible Cultural Heritage of India     | 89       |
| 15    | Prominent Universities of Ancient India   | 93       |

# 1

## CHAPTER

# Indian Architecture

Indian architecture has continuously blended indigenous techniques with external influences from the grid-planned brick cities of the Indus Valley to Mauryan pillars, Gupta temples, Sultanate arches, Mughal gardens and colonial revivals. Shifts in patronage and materials spurred new building types (stupas, caves, mosques, palaces), while modern & sustainable approaches reflect evolving cultural, technological and environmental priorities. Today's structures echo centuries of layered innovation and identity.

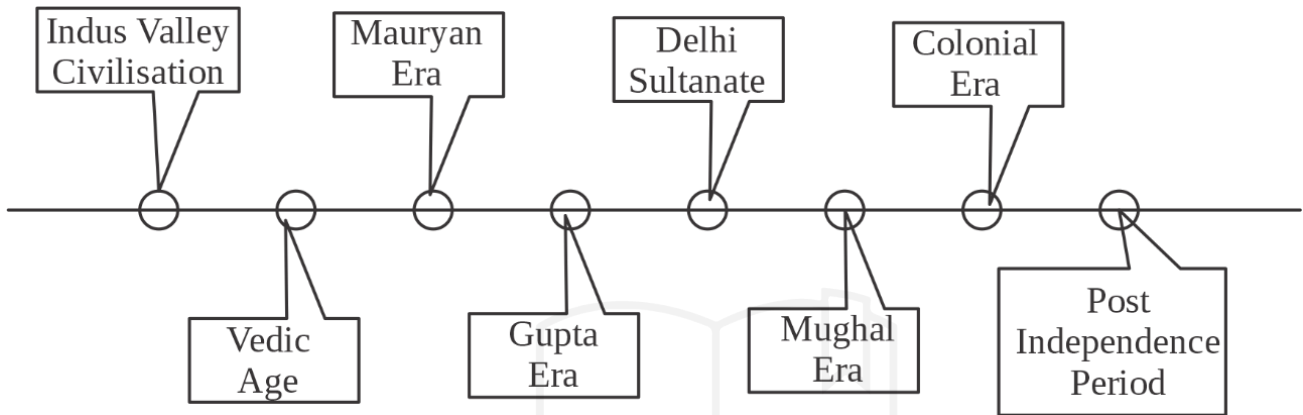

## Indus Valley Civilization

### ➤ Major Sites:

- ✓ **Harappa** (Punjab, Pakistan) → Featured the Cemetery H culture, granaries, working platforms, and burial grounds.
- ✓ **Mohenjo-daro** (Sindh, Pakistan) → Known for the Great Bath, assembly hall, large residential houses, and the priest-king statue.
- ✓ **Ropar** (Punjab) → Offers evidence of early burial practices and is located on the Sutlej River.
- ✓ **Kalibangan** (Rajasthan) → Revealed fire altars and ploughed fields, the earliest known evidence of agriculture, but no Great Bath was found.
- ✓ **Lothal** (Gujarat) → It was a significant maritime site with a dockyard, warehouse, bead-making factory, and seals. It is now the location for the National Maritime Heritage Complex (NMHC).
- ✓ **Rangpur** (Gujarat) → Late Harappan site, evidence of rice cultivation.
- ✓ **Dholavira** (Gujarat) → Had a unique stone-built, tripartite city plan and was known for its advanced water management systems.
- ✓ **Rakhigarhi** (Haryana) → 5,000-year-old Water Management Techniques unearthed at Harappan site.

### ➤ Urban Planning

- ✓ Cities were designed with rectangular street grids that intersected at right angles.
- ✓ The cities were divided into an upper town (citadel) and a lower town, both built on raised platforms.
- ✓ Streets & buildings were designed with slopes to efficiently direct water runoff.

➤ **Building Materials & Techniques**

- ✓ Buildings were primarily constructed using uniform burnt-mud bricks joined with gypsum mortar.
- ✓ At **Dholavira**, stone masonry was used instead of bricks, indicating unique architectural techniques.
- ✓ No evidence of arches or columns present in the architecture of the civilisation.

➤ **Residential Layout**

- ✓ Houses were typically multi-room structures arranged around central courtyards with flat roofs.
- ✓ Many had private wells & bathing areas; doors/windows rarely faced main streets for privacy.
- ✓ Use of staircases suggests some houses had upper floors.
- ✓ No central palace or temple complex indicates an egalitarian society.

➤ **Sanitation & Water Management**

- ✓ Covered drains from each house connected to main sewers; accessible for cleaning.
- ✓ Regular cess-pits and widespread wells helped manage waste and water distribution.
- ✓ **Dholavira**: Rainwater harvesting using interconnected tanks and channels.

➤ **Public & Defensive Structures**

- ✓ Cities were protected by fortified brick walls, designed to guard against floods and invasions.
- ✓ Granaries were constructed on raised plinths with air-ducts to prevent pests and preserve food supplies.
- ✓ The **Great Bath at Mohenjo-daro** was a central water tank surrounded by rooms, likely used for communal rituals or public bathing.

➤ **Citadel vs Lower Town**

| Citadel   | Lower Town   |
|---|--|
| Located in the <b>western part</b> .  | Located in the <b>eastern part</b> .   |
| <b>Smaller</b> than lower town.   | <b>Larger</b> than the citadel.  |
| Hosted large buildings like <b>granaries, administrative buildings, pillared halls, residences of the rulers and aristocrats, courtyards etc.</b> | Contained small <b>one-roomed houses, probably for working-class people.</b> |

**Mauryan Architecture (c. 322–185 BCE)**

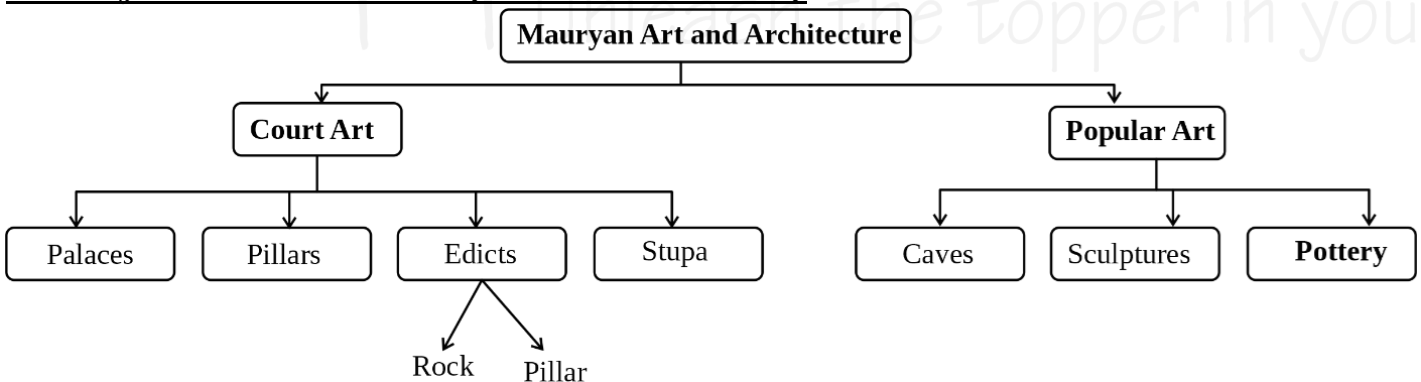

**1. Court Art (State-sponsored)**

➤ **Palaces**

- ✓ **Ashoka's Palace**: Located at Kumrahar, it was a multi-storey wooden structure with a central monumental pillar, showcasing architectural grandeur.
- ✓ **Chandragupta's Palace**: Situated in **Pataliputra**, it was modeled after the Achaemenid **Persepolis** (as described by Greek ambassador **Megasthenes**), symbolizing political and cultural influence.

## ➤ Ashokan Pillars

- ✓ These **monolithic Chunar sandstone shafts** were a key feature of Mauryan architecture, designed to convey royal power and imperial authority.
- ✓ Each pillar consisted of four main components:
  1. **Shaft:** single-piece stone.
  2. **Capital:** lotus- or bell-shaped top (bell-form shows Iranian influence).
  3. **Abacus:** circular/rectangular slab above capital.
  4. **Animal Figure:** lions, bulls, elephants atop abacus.
- ✓ Surviving examples: Lauriya Nandangarh, Rampurva (bull), Sankisa & Sarnath (lion).



## ➤ National Emblem

- ✓ The **Sarnath Lion Capital** serves as India's **national emblem**, with its four lions back-to-back, representing strength and pride.
- ✓ The **abacus** below the lions features animals that may symbolize key stages in **Buddha's life**.
- ✓ The **Dharma Chakra** (24-spoked wheel) represents the eternal wheel of law.
- ✓ The inscription "**Satyameva Jayate**" beneath the emblem signifies "Truth alone triumphs," highlighting moral authority and justice.



सत्यमेव जयते

## Ashokan vs Achaemenian Pillars

| Aspect                   | Ashokan (3rd c BCE)                  | Achaemenian (6th–4th c BCE)                  |
|--------------------------|--------------------------------------|--|
| <b>Purpose</b>           | Freestanding edicts promoting Dhamma | Support large palace/ceremonial structures   |
| <b>Material</b>          | Local sandstone                      | Limestone/sandstone                          |
| <b>Structure</b>         | Single monolith shaft + capital      | Multi-stone fluted shafts + complex capitals |
| <b>Religious Link</b>    | Buddhism                             | Zoroastrianism/Persian culture               |
| <b>Capitals</b>          | Realistic animals (lion, bull)       | Mythical creatures (griffins, twin bulls)    |
| <b>Message</b>           | Ethical and religious ethics         | Royal grandeur and divine authority          |
| <b>Animal depictions</b> | Naturalistic                         | Stylized or mythical                         |
| <b>Installation</b>      | Often solitary in open spaces        | Installed inside palace complexes            |

## ➤ Stupas (Burial Mounds)

- ✓ **Definition:** Solid hemispherical domes enclosing relics and ashes; pre-Buddhist origin, popularised by Buddhists.
- ✓ **Patrons:** From kings (Ashoka) to lay devotees & guilds; artisans named in a few inscriptions (e.g., Kanha at Pitalkhora).
- ✓ **Core Features**
  - Brick core with a burnt-brick or clay exterior.
  - **Drum:** A cylindrical structure topped with a **Harmika** (railing platform) and a **Chhatra** (umbrella-like structure).
  - **Pradakshina Patha:** A circumambulatory path enclosed by wooden railings and decorated with toranas (ornamental gateways).
  - **Symbolic reliefs:** Include motifs like lotus, elephants, and Jataka scenes.

✓ **Key Sites**

- **Sanchi (World Heritage Site):**
  - Lies to the west of Betwa river (Bhopal).
  - Three main stupas :
    - Stupa-1:** Buddha relics;
    - Stupa-2:** relics of ten arhats;
    - Stupa-3:** relics of Sariputta & Mahamougalayana
  - Ashokan lion pillar with an inscription found in southern side of stupa; unique upper pradakshina path.

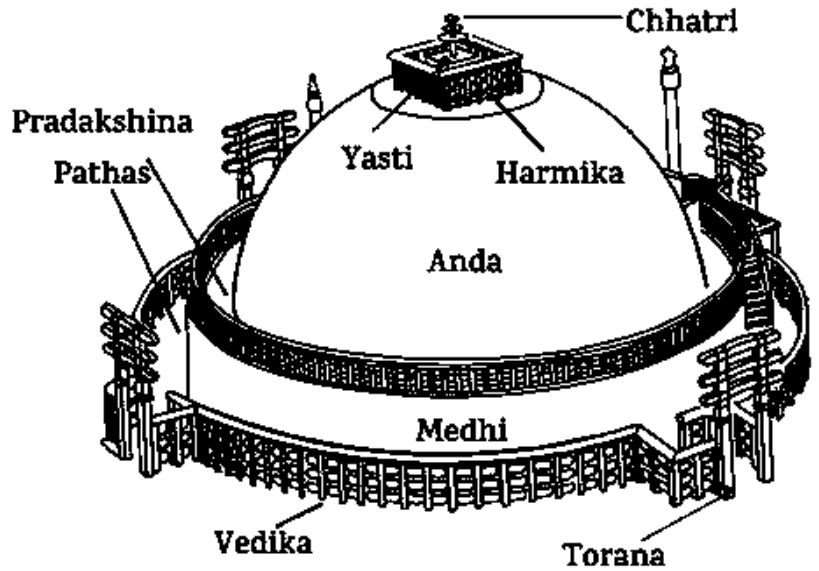

- Other notable sites: Bharhut, Bodh Gaya, Amravati, Nagarjunakonda.

**2. Popular Art (Locally Patronised)**

➤ **Rock-Cut Caves**

- ✓ **Origins:** First rock-cut caves built 3rd century BCE under Ashoka's patronage for the Ajivika sect, later used by Buddhists and Jains.
- ✓ **Key Sites:** **Barabar Hills** (Lomas Rishi, Sudama, Vishvakarma, Karan Chaupar) & Nagarjuni (Vadathi-ka-kubha, Vape-ka-kubha, Gopi-ka-Kumbha) in Bihar.
- ✓ **Polished Interiors:** Exquisitely smoothed rock surfaces - hallmark "Mauryan polish" - creating austere, meditative chambers.
- ✓ **Decorative Entrances:** Semicircular "chaitya-arch" motifs carved over rectangular or circular doorways (prototype for later Buddhist chaityas).
- ✓ **Minimalist Layout:** Single-cell halls or small viharas with bare interiors for monastic living & meditation.
- ✓ **Later Adaptations:** Subsequent sites like Nasik's Pandav Leni (1st BCE–3rd CE) expanded into multi-cell viharas & chaitya halls with sculpted reliefs.



➤ **Pottery & Sculpture**

- ✓ **Northern Black Polished Ware (NBPW):** Known for its lustrous finish and highly reflective surface, this pottery was of fine quality and used in urban centers.
- ✓ **Sculptural Decoration:** Featured on stupas, toranas, and cave facades, with a narrative style that avoided direct depiction of human divinities.



**Post-Mauryan - Gupta Period (2nd BCE-6th CE)**

➤ **Chaityas & Viharas**

| Chaityas  | Viharas  |
|---|--|
| <ul style="list-style-type: none"> <li>➤ Used as prayer halls.</li> <li>➤ Chaityas were with Stupas.</li> <li>➤ These have a small rectangular doorway that opens to a vaulted Hall with an apsidal end. At the end, there is a stupa.</li> </ul> | <ul style="list-style-type: none"> <li>➤ Residential places for Buddhist and Jain monks.</li> <li>➤ Viharas did not have stupas.</li> <li>➤ They consist of a main hall, assembly hall and dining chambers.</li> </ul> |

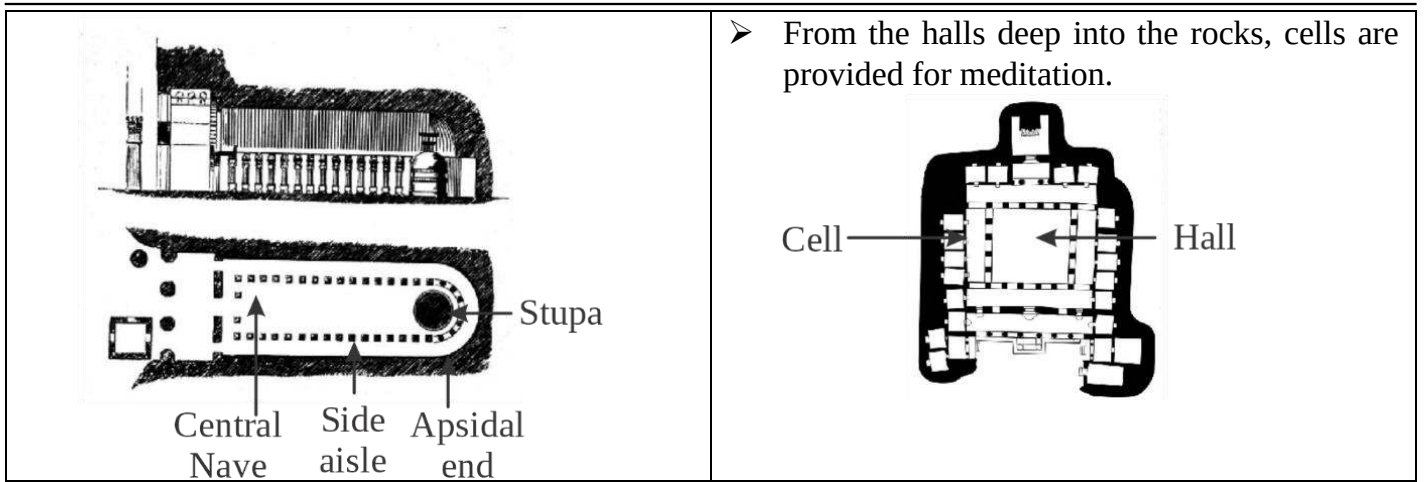

➤ **Western India Types:**

- ✓ **Apsidal, vaulted chaitya halls:** Found in Ajanta, Bhaja, and Pitalkhora, featuring semi-circular or apsidal halls with vaulted roofs.
- ✓ **Pillar-less apsidal halls:** Notable examples include Thana-Nandur in Maharashtra.
- ✓ **Flat-roofed quadrangular halls:** Found in Kondivite, these halls featured rear circular chambers.
- ✓ Use of basalt rock for rock-cutting enabled elaborate carving.

➤ **Key Western Sites:**

- ✓ **Karla:** Known for the largest chaitya hall, with richly sculpted facades.
- ✓ **Pandavleni (Nasik):** vihara cells with ghata-base capitals.
- ✓ **Ganeshleni (Junnar) & Kanheri (Mumbai):** extensive vihara networks.
- ✓ **Bhaja caves (Pune):** Famous significant Buddhist cave.
- ✓ **Bedsa caves:** known for well-preserved pillars and sculpted lions.
- ✓ **Kondane caves:** early example of wooden architectural imitations in stone.



➤ **Eastern India Highlights:**

- ✓ **Guntupalle (Andhra Pradesh):** unique cluster of stupa, chaitya and vihara.
- ✓ **Anakapalli & Dhanyakataka (Andhra Pradesh):** massive rock-cut stupas and viharas.
- ✓ **Udayagiri-Khandagiri (Odisha):** Jain monastic caves with bold reliefs.
- ✓ **Jaggayapeta (Andhra Pradesh):** Important site with richly decorated stupas.
- ✓ **Aryaka Pillars (Andhra Pradesh):** Found in **Buddhist stupas** at **Nagarjunakonda**, these pillars supported platforms or railings around stupas and were integral to monastic complexes during the **Ikshvaku period** (3rd–4th century CE).

➤ **Art & Decoration:**

- ✓ Early caves bear semicircular chaitya arches that prefigure later Buddhist gateways.
- ✓ Later sites include narrative reliefs (Jataka scenes), sculptures of the Buddha, Bodhisattvas, and local folk deities.
- ✓ Murals at Ajanta exhibit Gupta-style elegance and narrative depth.
- ✓ Yaksha & Yakshini motifs continue alongside Buddhist themes in decorative elements.

---

## Gupta Architecture “Golden Age”

### 1. Rock-Cut Caves:

- ✓ **Ajanta:** Comprising 25 viharas and 4 chaityas, with phases spanning from the 2nd BCE to 5th CE, under Vakataka patronage.
- ✓ **Ellora:** A complex of 34 caves, with 17 Brahmanical, 12 Buddhist, and 5 Jain caves, dating from the 5th to 11th century, featuring triple-storey halls.
- ✓ **Elephanta:** A collection of 5 Hindu and 2 Buddhist caves, showcasing notable sculptures like Maheshmurti and Nataraja.
- ✓ Other sites: **Bagh** (Satavahana, Rang Mahal reliefs), **Junagadh**, **Mandapeshwar**, **Udayagiri** (Chandragupta II's Varaha).

### 2. Stupas & Terracotta:

- ✓ Post-Mauryan stone stupas: Samat, Ratnagiri, Mirpur Khas, Dhamek; Devnimori outside Gangetic plain.
- ✓ Clay figurines & red ware pottery found at Ahichchhatra, Rajgarh, Hastinapur.
- ✓ Terracotta plaques depict scenes from daily life, domestic deities, and nature motifs, reflecting folk aesthetics.
- ✓ **Devnimori stupa** (Gujarat) reveals a blend of Gandhara & Gupta influences, transition phase art.

### 3. Key Temple Examples:

- ✓ Parvati, Nachnakuthara; Ter (Maharashtra ); Maniyar Math( Rajgir).
- ✓ **Bhitargaon Temple (UP):** Earliest known large brick shikhara temple; shows vertical elevation concept.
- ✓ **Dashavatara Temple, Deogarh (UP):** Earliest example of a full-fledged Gupta shikhara temple; depicts Vaishnava themes.

### 4. Artistic Highlights:

- ✓ Introduction of mural paintings in caves
- ✓ Synthesis of classical sculpture forms, dynamic iconography in both stone & metal.
- ✓ **Gupta bronzes** (e.g., Sultanganj Buddha) show refined casting, drapery & gentle modeling of figures.
- ✓ **Gupta art** is characterized by Sthira-lakshana (calm expression), symbolizing spiritual transcendence.
- ✓ Buddhist, Jain, & Hindu iconographies were harmoniously developed side-by-side during Gupta era.

---

## Indo-Islamic Architecture (c. 12th–18th CE)

### 1. General Features

- ✓ **Arcuate Style:** Incorporation of true arches and domes with voussoirs and keystones, with minarets surrounding mosques.
- ✓ **Ornamentation:** Features arabesque patterns, calligraphy, geometric jali screens, and pietra-dura inlay; the use of charbagh gardens (four-part gardens) with water channels and fountains.
- ✓ **Materials:** Brick, lime-mortar, sandstone, marble.
- ✓ **Mihrab (prayer niche) & minbar (pulpit)** became integral parts of mosque architecture.
- ✓ **Iwan** (vaulted hall with one open side) adopted from Persian architecture.

---

## 2. Delhi Sultanate (Imperial Style)

- ✓ **Slave (Mamluk) Dynasty:** Key architectural contributions include the **Qutb Minar complex** (built by **Aibak**, **Iltutmish**, and **Feroz Shah**), and the **Quwwat-ul-Islam Mosque** (c. 1197), which employed recycled temple materials. The tomb arch innovation was introduced under **Balban**.
- ✓ **Khalji** (1290–1320): Notable for the **Alai Darwaza**, the first true dome, and the use of **red sandstone** and **marble ornamentation**.
- ✓ **Tughlaq:** Known for sloping “batter” walls, 4-centred arches & **octagonal tombs** (e.g., **Ghiyasuddin Tughlaq's tomb**). The **Tughlaqabad Fort** is an example of their **fortified cities**.
- ✓ **Lodi:** Famous for **octagonal garden-tombs** (e.g., **Sikander Lodi's tomb**), with simpler decorative elements. Public works included **saris**, **bridges**, and **baolis** (stepwells), such as **Gandhak ki Baoli** built by **Iltutmish**.

## 3. Provincial Styles

- ✓ **Bengal:** Known for sloping cornice roofs and brick/glazed-tile decoration, as seen in the Qadam Rasul and Adina Mosque.
- ✓ **Jaunpur:** Notable for the absence of minarets in structures like Atala Mosque and Lal Darwaza Mosque.
- ✓ **Malwa:** Features contrast-stone facades and large arched halls, as in the Hindola Mahal.
- ✓ **Deccan (Bijapur):** Bulbous domes and 3-arched facades, exemplified by Gol Gumbaz with its famous whispering gallery.
- ✓ **Gujarat Style:** Known for richly carved minbars and mihrabs, seen in the Jama Masjid in Ahmedabad. This style blended Islamic forms with Hindu-Jain detailing.
- ✓ **Kashmir:** Features deodar wood and distinctive wooden mosques with pyramidal roofs, such as the Khanqah-e-Moula.

## 4. Mughal Architecture

- ✓ **Babur & Humayun:** Early mosques; Humayun's Tomb (first Persian-Indian synthesis; charbagh; double dome architecture).
- ✓ **Sher Shah:** Transitional Lodi–Mughal (Purana Qila, Sasaram tomb).
- ✓ **Akbar:** Fusion style at **Fatehpur Sikri** (Buland Darwaza, Panch Mahal, Ibadat Khana).
- ✓ **Jahangir & Nur Jahan:** Tombs at Sikandra & Agra (I'timad-ud-Daulah).
- ✓ **Shah Jahan:** Zenith of pietra-dura & marble (Taj Mahal, Red Fort's Diwan-i-Khas with Peacock Throne dais).
- ✓ **Aurangzeb:** Puritanical works (Badshahi Mosque, Bibi-ka-Maqbara).
- ✓ **Civic Projects:** The Mughals constructed key civil works such as the bridge over the Gomati River at Jaunpur and Grand Trunk Road revival (Sher Shah), West Yamuna Canal, Jaunpur bridge.
- ✓ In 1784, Nawab Asaf-ud-Daula built the Bada Imambara in Lucknow using an interlocking brick technique that required no mortar.
- ✓ Asaf-ud-Daula also commissioned the **Rumi Darwaza** in Lucknow, crafted from brick and finished with a lime plaster coating.
- ✓ **Use of Hasht-Bihisht (eight-part plan)** became standard in Mughal tomb architecture (e.g., Humayun's Tomb, Taj Mahal).
- ✓ **Jharokhas (balconied windows)** were introduced to integrate local Hindu styles within Mughal aesthetics.
- ✓ **Chhatris** (domed kiosks) crowned Mughal structures, giving a distinctive skyline.

---

## Colonial & Modern Architecture

### 1. 16th–17th c. – Portuguese Baroque

- ✓ **Influence:** Iberian church and civic designs, blending Mannerist and Baroque styles with local adaptations.
- ✓ **Features:** Internal courtyards, bold color contrasts, use of laterite stone and lime plaster for coastal buildings.
- ✓ **Examples:** Se Cathedral & Basilica of Bom Jesus (Goa); Diu Fort.

### 2. 17th–18th c. – French Colonial Planning

- ✓ **Influence:** Rational urban grids and civic squares integrated with tropical town plans.
- ✓ **Features:** European church forms combined with local architectural styles, promenade-style riverfronts, and wide boulevards for civic aesthetics.
- ✓ **Examples:** Puducherry (grid layout, Sacred Heart Church); Chandannagar.
- ✓ Promenade-style riverfronts and wide boulevards designed for civic aesthetics.

### 3. 19th c. – British Indo-Gothic Revival

- ✓ **Influence:** Victorian Gothic craft mixed with Mughal/Persian motifs.
- ✓ **Features:** Pointed arches, traceried windows, ornamental facades with jali screens.
- ✓ **Examples:** Victoria Memorial (Kolkata), Gateway of India (Mumbai).
- ✓ Other examples include Bombay High Court and CST Railway Terminus.
- ✓ **Civic Elements:** Clock towers, spires, and stained glass, reflecting European symbolism.

### 4. Post-1911 – Lutyens' Neo-Roman Delhi

- ✓ **Influence:** Classical Roman and Baroque symbolism for Empire
- ✓ **Features:** Grand colonnades, massive domes, axial vistas; hybrid of Western orders.
- ✓ **Examples:** Secretariat Buildings, Rashtrapati Bhavan extensions.
- ✓ Lutyens collaborated with Herbert Baker, designed symmetrical layouts with Mughal charbagh influence.
- ✓ Red and cream Dholpur sandstone prominently used.
- ✓ Incorporation of jaali screens (chhajja and chhatris) to provide climatic adaptability and cultural fusion.

### 5. 1950s–70s – Post-Independence Modernism

- ✓ **Influence:** International Style & Brutalism
- ✓ **Features:** Pilotis, raw concrete, brise-soleil sun-shades, sector-based city planning.
- ✓ **Examples:** Chandigarh Capitol Complex (Le Corbusier); Supreme Court of India.
- ✓ Integration of Vastu principles with modularity in housing schemes (e.g., Delhi Development Authority blocks).
- ✓ Use of exposed concrete (beton brut) and geometric abstraction in form.

### 6. 1970s–90s – Vernacular Revival

- ✓ **Influence:** Regional climate, materials & crafts
- ✓ **Features:** Courtyard-centric layouts, passive cooling, local stone & brick.
- ✓ **Examples:** IIM Ahmedabad (Balkrishna Doshi); Kanchanjunga Apartments (Charles Correa).
- ✓ Architects like Laurie Baker promoted low-cost, sustainable, people-centric architecture.
- ✓ Use of rat-trap bond brickwork, filler slabs & jali walls for thermal regulation.

### 7. 2000s–Present – Sustainable & High-Tech

- ✓ **Influence:** Green building standards & digital design.
- ✓ **Features:** Energy-efficient façades; rainwater harvesting; smart HVAC; living walls.
- ✓ **Examples:** CII-Sohrabji Godrej Green Business Centre; Lotus Temple (Delhi)
- ✓ Platinum LEED-certified campuses emerging across IT and educational hubs.
- ✓ Digital parametric design, solar panels, and green rooftops widely adopted.
- ✓ Biophilic architecture trends, integration of plants, water, and light into building interiors.

Indian architecture is not static. It is adaptive, inclusive, and layered. It bridges the ancient and the futuristic, sacred and secular, local and global, making it a living heritage that continues to evolve while preserving its soul.

---

# 2

## CHAPTER

# Temple Architecture

Temple architecture in India is one of the most distinctive and enduring expressions of Indian culture, reflecting the country's religious devotion, artistic creativity, and regional diversity. Evolving over more than two millennia, Indian temples are not just places of worship, they are cosmic diagrams, cultural centers & symbols of spiritual ascent.

## A. Early Hindu Temples

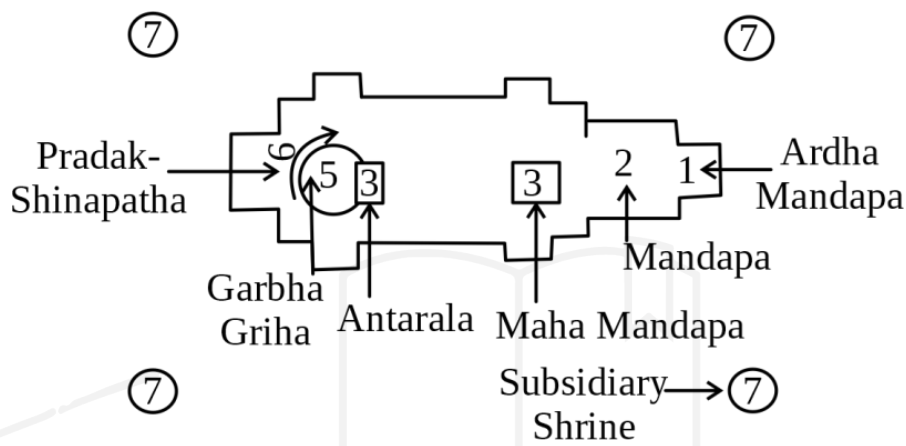

### ➤ Historical Context:

- ✓ From the 1st century BCE, Brahmanical shrines emerged alongside Buddhist stupas, reflecting the growing popularity of temple worship and the installation of principal deity images.
- ✓ Patronage came from Guptas, local rulers, and guilds, indicating growing religio-political alignment.

### ➤ Plan Types:

- ✓ **Sandhara:** No enclosed pradaksina path; circumambulation takes place around the outer maṇḍapa.
- ✓ **Nirandhara:** Three-sided internal corridor (pradakṣiṇa-patha) directly surrounding the garbhagr̥ha.
- ✓ **Sarvatobhadra:** Fully accessible four-sided corridor permitting 360° circumambulation.

### ➤ Architectural Composition:

- ✓ Typically featured a veranda (mukha-maṇḍapa), a main hall (maṇḍapa), and a rear shrine (garbhagr̥ha).
- ✓ Roof forms varied: flat, sloping, or early proto-shikhara domes.
- ✓ Ornamentation began modestly, lotus medallions, floral bands, yaksha - yakshini reliefs.

### ➤ Notable Examples:

- ✓ **Deogarh (UP):** Early Gupta sandstone temple with plain exterior, relief panels (Dashavatara).
- ✓ **Eran & Udayagiri (MP):** Small rock-cut nirandhara shrines with carved pillars.
- ✓ **Nachna-Kuthara (MP):** Prototype sarvatobhadra, square sanctum with four-sided ambulatory.

## **Evolution of Temple Architecture**

During the Gupta era, temple design evolved in five distinct stages, moving from simple, flat-roofed structures to more complex sanctums crowned by sculpted shikharas.

### ➤ **Stage I**

- ✓ Square-plan shrine with a flat roof.
- ✓ Built on a low, single-tiered platform.
  - Example: Udayagiri Cave 5 Temple (Madhya Pradesh)

### ➤ **Stage II**

- ✓ Platform raised to form a higher plinth.
- ✓ Emergence of two-storeyed temples.
- ✓ Addition of a covered circumambulatory corridor (Pradakshina Patha) around the garbhagriha.
- ✓ Example: Parvati Temple at Nachana Kuthara (Madhya Pradesh)

### ➤ **Stage III**

- ✓ Flat roof replaced by a rising shikhara (tower).
- ✓ Introduction of the Panchayatana layout (main shrine surrounded by four subsidiary shrines).
- ✓ Example: Dashavatara Temple, Deogarh (Uttar Pradesh), crowned by a modest pyramidal shikhara over the sanctum.

### ➤ **Stage IV**

- ✓ Continuation of shikhara form, with the garbhagriha becoming more rectangular in plan.
- ✓ Example: Ter Temple (Maharashtra)

### ➤ **Stage V**

- ✓ Development of circular sanctums with shallow rectangular projections.
- ✓ Example: Maniyar Math (Rajgir, Bihar)

## **B. Components of a Hindu Temple**

### ➤ **Garbhagriha:**

- ✓ Inner sanctum for the main deity, originally a simple cell, later expanded.
- ✓ Symbolizes Brahmanda (cosmic womb) & is kept dark to enhance spiritual experience.
- ✓ Oriented generally eastward, symbolizing light and knowledge.

### ➤ **Mandapa:**

- ✓ Entrance hall or portico for congregational worship.
- ✓ Can be open or enclosed; in later periods, multiple mandapas (ardha-mandapa, maha-mandapa) developed.
- ✓ Served as space for devotional music, dance and discourse.

### ➤ **Shikhara/Vimana:**

- ✓ The roof-tower- curvilinear in the North (shikhara) or stepped-pyramidal in the South (vimana).
- ✓ Shikhara in the North developed into rekha-prasad (linear) & phamsana (pyramidal roof over mandapas).
- ✓ Vimana in the South evolved into tiered Dravida towers with intricate miniature shrines.

### ➤ **Pradakshinapatha:**

- ✓ Enclosed walkway for circumambulation (nirandhara & sarvatobhadra types).
- ✓ Symbolizes clockwise movement of the cosmos and dharma.
- ✓ Often marked by pillars, relief panels, or symbolic motifs for meditative aid.

➤ **Vahana & Dhvaja:**

- ✓ Deity's mount and flag-staff placed on the axis before the sanctuary.
- ✓ Vahana (e.g. Nandi for Shiva, Garuda for Vishnu) acts as a mediator between devotee and deity.
- ✓ Dhvaja stambha (flagstaff) represents victory of dharma and is usually placed axially before temple entry.

### C. Styles of Temple Architecture

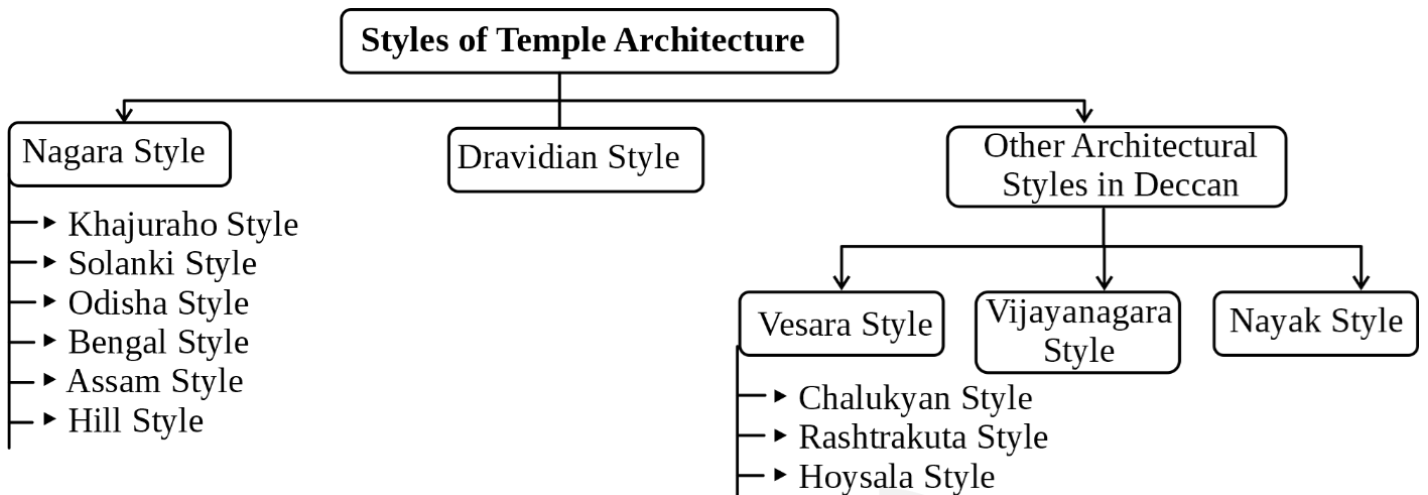

#### 1. Nagara Style (Northern India)

➤ **General Traits**

- ✓ Built on raised stone plinths; rarely enclosed by massive boundary walls or grand gateways.
- ✓ Often follow the Panchayatana style layout: main shrine at centre with four subsidiary shrines at the corners.
- ✓ Unlike Dravida style, Gopurams are absent; the main shikhara dominates the skyline.
- ✓ Use of intricately carved toranas (arched gateways) in select regions like Gujarat.

➤ **Vertical Profile**

- ✓ **Pitha:** The base platform that supports the structure, often elevated to enhance the sanctity of the space.
  - ✓ **Garbhagriha:** The sanctum housing the main deity of the temple.
  - ✓ **Amalaka:** A ribbed stone disc placed above the garbhagriha, symbolizing the sun or the cosmic fruit, representing divine energy.
  - ✓ **Kalasha:** The finial pot placed at the top of the temple, signifying prosperity, completeness, and the divine presence.
- **Shikhara Variants**
- ✓ **Latina (Rekha-prasada):** smooth curving tower rising from a square plan.
  - ✓ **Phamsana:** stepped, pyramidal slabs typically over mandapas.
  - ✓ **Valabhi:** wagon-vaulted rectangular roof, echoing Buddhist chaitya halls.

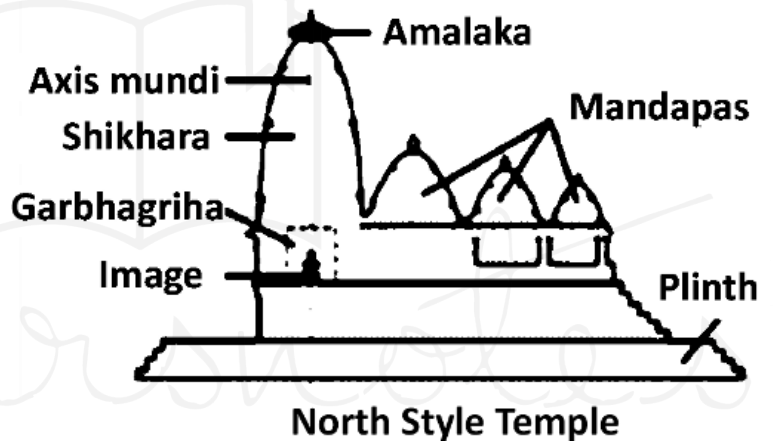

Latina



Phamsana



Valabhi

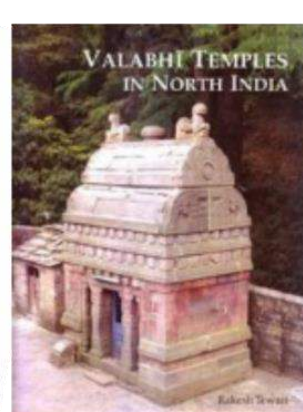

## ➤ Regional Highlights

### ✓ Central India

- **Dashavatara Temple, Deogarh** (early 6th c): Features a classic latina shikhara and reliefs of Vishnu in forms like Sheshashayana (Vishnu resting on serpent) and Gajendramoksha (Vishnu saving the elephant).
- ✓ **Khajuraho, Madhya Pradesh** (Chandelas, 10th–11th c)
  - **Lakshmana Temple** (954 CE): prominent amalaka & kalasha.
  - **Kandariya Mahadeva** (1003–35 CE): multiple clustered shikharas; erotic Malini sculptures.
- ✓ **Modhera Sun Temple, Gujarat** (Solanki, 1026 CE)
  - East-facing sanctum aligned to equinox sun; Surya Kund stepped tank with 108 mini-shrines.
- ✓ **Chausath Yogini Temple, Morena, Madhya Pradesh** (11th c)
  - Circular plan, 64 goddess shrines; inspired modern Indian parliament design.
- ✓ **Assam- Kamakhya** (8th–17th c)
  - Nilachal dome; garbhagriha with a yoni-shaped cleft instead of murti; pancharatha plan; tantric deities are depicted in relief.
- ✓ **Bengal**
  - Pala–Sena period temples: tall curving shikharas crowned by large amalakas.
  - **Terracotta brick shrines** (17th c): Characterized by "Bangla" roofs, such as ek-chala, doi-chala, char-chala, and aatchala.
- ✓ **Odisha (Kalinga)**
  - Orders: Rekha-pida (sanctum), Pidha-deul (assembly), Khakhara-deul (rectangular).
  - Jagannath (Puri); Lingaraj, Bhubaneswar (Somavamshi, 11th c) .
  - **Konark Sun Temple** (1240 CE): chariot-form plan, 12 pairs of carved stone wheels.

### DID YOU KNOW?

Ratna Bhandar, the sacred treasury of Shree Jagannath Temple, Puri reopened after 46 years.



### ✓ Hill & Mountain Traditions

- **Wooden-Frame Temples**: Pitched roofs with carved struts; integration with natural topography.
- **Stone Adaptations**: Grey limestone and ashlar masonry in Kashmiri shrines; stepped pyramidal roofs (Martand Sun Temple).
- Karkota Period ,(Kashmir): **Pandrethan Temple** – peaked profile slanting outward; fusion of Gandharan and local motifs.

- **Chamba (Himachal):** Post-Gupta stone sculptures of Mahishasuramardini and Nārasimha; use of copper-zinc alloys.
- **Hidimba Temple (Manali):** Pagoda-style wood and stone construction; circular sanctum set in forest clearings.

## 2. Dravida Style (Southern India)

### Features

#### ➤ Enclosure & Gateways:

- ✓ Temples are set within high compound walls for seclusion.
- ✓ The main entrance is a monumental gopuram, often flanked by sculpted dvarapalas (door-keepers).
- ✓ Stucco **figures** of deities, demons & mythical beings decorate the gopurams.

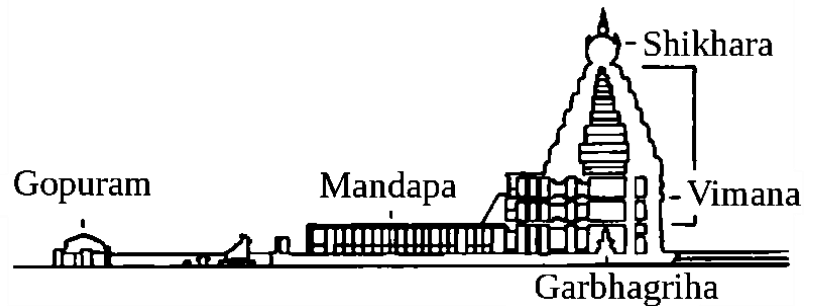

#### ➤ Water Features:

- ✓ Large temple tanks or reservoirs are integral to the complex.
- ✓ Tanks like Pushkarini or Kalyani are considered ritually purifying and are used for temple festivals.
- ✓ Ritual bathing, water processions, and float festivals (e.g., Teppotsavam) are tied to temple tanks.

#### ➤ Core Components:

- ✓ **Garbhagriha** (sanctum sanctorum): The central shrine housing the deity.
- ✓ **Vimana**: The main tower above the garbhagriha, usually in a stepped pyramid form.
- ✓ **Mandapa**: A pillared hall used for assembly or rituals.
- ✓ **Shikhara**: The capping element or cupola, called **stupika** in the south.
- ✓ Other features include **subsidiary shrines**, **kitchen halls (Paka-shala)**, and **rest houses**.

#### ➤ Plan & Shape Variations:

- ✓ There are five types of **vimana plans**: **square** (kuta), **rectangular** (shala), **elliptical** (gajaprishta), **circular** (vritta), and **octagonal** (ashtasra), chosen based on the deity's iconography.
- ✓ **Sthapati** (temple architects) adhered to strict rules outlined in **Agamas** and **Vastu Shastra** for the layout and orientation of the temple.
- ✓ **Superstructures** typically have **talas** (storeys), each marked by miniature shrines (kutas, salas) or pilasters.

#### ➤ Regional Hubs:

- ✓ **Kanchipuram**, **Thanjavur**, **Madurai**, and **Kumbakonam** emerged as major urban centers around **Dravida temples**.
- ✓ **Chidambaram**: Famous for its Nataraja temple- symbolic of cosmic dance.
- ✓ **Mahabalipuram**: Early Pallava rock-cut temples & rathas (monolithic shrines).
- ✓ **Srirangam**: The largest functioning Hindu temple complex in India, known for its multi-gopuram structure.

#### ➤ Political Role:

- ✓ From the 8th–12th centuries, temple complexes also functioned as administrative and land-holding centres.
- ✓ Inscriptions on temple walls record donations, taxes, and community rules- key sources of history.

---

## 2.1. Prominent Dravida Architectures (Dynasty wise)

### ➤ Pallava Architecture (c. 2nd–9th Century AD)

- ✓ **Origins:** Pallavas migrated from **Andhra** & pioneered **stone temple construction** in Tamil Nadu.
- ✓ **Four Phases:**
  - **Mahendra Group:** Earliest rock-cut mandapas; Mandagapattu inscription claims no brick, timber or mortar used.
  - **Narasimha Group:** Ornate rock-cut shrines; Panch Pandava Rathas (Dharmaraja, Bhima, Arjuna, Nakula, Sahadeva) at Mahabalipuram.
  - **Rajasimha Group:** First freestanding structural temples. Shore Temple at Mahabalipuram, Kailasanatha at Kanchipuram.
  - **Nandivarman Group:** Smaller shrines largely following earlier Dravida idioms. Less innovation.
- ✓ **Mahabalipuram (UNESCO World Heritage Site)**
  - **Pancha Pandava Rathas:** Five rock temples, each in Dravida style, commissioned by Narasimhavarman I (630–668 AD).
  - **Cave Temples:** Varaha, Krishna, Pancha Pandava, Mahishasuramardini, cut into hillocks, featuring lion-pillar mandapas.
  - **Open-Air Reliefs:** “Descent of the Ganges” (Arjuna’s/Bhagiratha’s Penitence) spans 27 × 9 m.
  - **Shore Temple Complex:** Three shrines (two small, one large) dedicated to Shiva and Vishnu (Anantashayana sculpture); evidence of early gopuram and water tank.
  - **Varahamandapa Cave:** Behind the penance relief; noteworthy for the boar’s snout realism and twin lion pillars.

### ➤ Chola Architecture

- ✓ **Early Phase:** Modest-sized shrines with numerous ‘ganas’ (attendant figures) on walls; examples include Vijayalaya Cholisvara (Narthamalai).
- ✓ **Imperial Phase:**
  - **Brihadeeswara Temple (Thanjavur, 1010 AD):** Part of “Great Living Chola Temples” UNESCO group; pyramidal vimana with monolithic octagonal stupika; principal deity, Shiva.
  - Other masterpieces: Airavatesvara (Darasuram), Gangaikonda Cholapuram (by Rajendra I).
  - **Abathsayeswarar Temple (Thanjavur, Tamil Nadu)** - chosen to receive the UNESCO Award of Distinction, 2023 for conserving its heritage.

## Vesara & Deccan Regional Styles

- Vesara blends a Nagara-style square/cruciform base with a Dravidian-style tiered, pyramidal superstructure topped by a curvilinear shikhara. Its open ambulatory with lathe-turned pillars and richly carved doorways/ceilings fuse North–South motifs.
  - ✓ **Badami (Vatapi):**
    - Hybrid of Nagara (curvilinear shikhara) and Dravida (sculptural richness); open ambulatory halls.
    - Includes both rock-cut and structural temples; earliest Dravida examples from the 6th century.
    - Introduced pillared verandahs and relief panels that bridge Buddhist, Jain, and Hindu
-

- 
- ✓ **Western Chalukya:**
    - Soft sandstone temples; both cave (Badami) and structural (Pattadakal, Aihole).
    - Use of multi-faceted pillars and composite capitals.
    - Initiated the Kadamba nagara tower, a stepped pyramidal shikhara in early transitional form.
  - ✓ **Aihole:**
    - **Durga Temple:** Features an **apsidal plan** similar to **Buddhist chaityas**.
    - **Lad Khan Temple:** Imitates **wooden prototypes in stone**.
    - Over **120 temples**, earning Aihole the title "**Cradle of Indian Temple Architecture**".
    - **Meguti Jain Temple:** Includes one of the earliest Kannada inscriptions from the **Pulakeshin II period**.
  - ✓ **Pattadakal:**
    - **Virupaksha Temple** (by Queen Lohamahadevi): Blends Pallava motifs.
    - **Papanatha Temple:** Exemplifies Dravida form.
    - **Eastern Chalukyan shrines** (e.g., Mahakuta, Swarga Brahma) show northern influences.
    - **Virupaksha temple** inspired by Kanchipuram Kailasanatha.
  - ✓ **Rashtrakuta & Ellora -**
    - **Kailashnath Temple (Ellora, 8th c.):** Single-rock Dravida shrine to Shiva with Nandi pavilion and gopuram-style gateway; comparable to Chalukya Lokeshvara at Pattadakal.
    - Carved from top to bottom, a unique feat in world rock architecture.
    - Features trivikrama, Ravana shaking Kailash, and Shaiva panels in sculptural narrative.
  - ✓ **Hoysala Architecture (1050–1300 AD)**
    - **Material & Plan:** Soapstone enabled intricate carvings; stellate (star-shaped) plan on a raised jagati platform.
    - **Key Features:** Multiple shrines around central mandapa; profuse wall reliefs of gods, dancers, epic scenes.
    - Highly ornamented ceiling panels, carved lathe-turned pillars & multi-tiered vimanas.
    - Delicate jewelry-like carving, sometimes attributed to individual sculptors (e.g., Dasoja, Mallitamma).
  - ✓ **Notable Temples:**
    - Hoysaleswara (Halebidu, 1150 AD) – Shiva Nataraja focus.
    - Chennakesava (Belur, Somanathapura) – Vaishnava triad forms.
    - Sri Madhava Perumal Temple - dedicated to Thondreshwaramudiayar (Lord Shiva). Inscriptions found at Sri Madhava Perumal Temple, which has largely remained submerged by Bhavanisagar dam, revealed a 1000 years old trade route.
  - ✓ **Vijayanagara “Provida” Style (1335–1565 AD)**
    - **Synthesis:** Fused Chola, Hoysala, Pandya, Chalukya idioms with Indo-Islamic elements.
    - **Distinctive Elements:**
      - a. Multi-storied raya gopurams on all sides.
      - b. Amman shrines for the deity’s consort (e.g., Hazara Temple, Hampi).
      - c. Kalyana mandapas for divine weddings; monolithic pillars.
      - d. Secular structures within temple courtyards (Lotus Mahal, council halls)
      - e. Characterized by tall granite enclosures, open pillared mandapas, and monolithic structures.
      - f. Use of Yali (mythical lion) pillars, and Kalyanamandapas with celestial wedding reliefs.
-

- **Major Complexes:**
  - a. Virupaksha Temple (expanded by Krishnadeva Raya) – carved pillars, royal inscriptions. Temple is dedicated to Lord Virupaksha (or Pampapathi), a form of Shiva and consort of the local goddess, Pampadevi.
  - b. Vitthala Temple – iconic stone chariot street; musical pillars.
- ✓ **Nayaka Architecture (16th–18th Century AD)**
  - **Characteristics:** Extension of Dravida style with Islamic influences; vast prakarams (corridors) encircling garbhagriha; pinnacle of gopuram art.
  - **Exemplar:**
    1. Meenakshi Temple, Madurai – towering multi-storied gopurams richly adorned with sculpture.
      - a. Heavy use of vibrant stucco figures, painted ceilings, and festive architectural ornamentation.
      - b. Integrated chariot streets, flag masts, and tall dipa-stambhas (lamp towers) into temple planning.
    2. Alagar temple, Tamil Nadu - Located on the foothills of Alagar hills in Madurai, Tamil Nadu.
      - a. The temple is one of the 108 abodes of Lord Vishnu, worshipped here in the name of Kallazhagar.
      - b. It has six corridors surrounded by fort walls.
      - c. The temple also finds mention in Tamil epic Silappadikaram and in the hymns of the Alvars.

### DID YOU KNOW?

The procession of the Lord Kallazhagar back from the Vaigai river marked the end of the Chithirai festival.



## D. Jain & Other Major Sites

- **Pan-India Presence**
  - ✓ Jain communities commissioned temples from the Deccan to Central India.
  - ✓ Notable Deccan sites: Ellora and Aihole feature early rock-cut and structural Jain shrines.
  - ✓ Central Indian centres: Deogarh, Khajuraho, Chanderi, Gwalior preserve exquisite Jain temples.
- **Karnataka**
  - ✓ Shravanabelagola: Home to the 18 m monolithic statue of Gomateshwara, the world's tallest free-standing monolith.
  - ✓ The site hosts the Mahamastakabhisheka ceremony once every 12 years, drawing pilgrims worldwide.
- **Rajasthan & Gujarat**
  - ✓ Mount Abu (Dilwara Temples): Built under Vimal Shah; plain exteriors conceal lavish marble carvings.
  - ✓ Palitana Hills: Cluster of Svetambara temples at Shatrunjaya, anchored by the main shrine of Rishabhanatha. Palitana is regarded as the 'Tirthraj' (King of Tirthas).
- **Jharkhand**
  - ✓ Parasnath Hill (Sammet Shikharji): Venerated by both Digambara and Svetambara sects; site where 20 Tirthankaras attained moksha.
  - ✓ Sammet Shikharji is considered one of the five holiest Jain tirthas along with Shatrunjaya, Girnar, Champapuri, and Pawapuri.

---

## **E. Hindu & Other Major Temples**

- **Venkateswara Temple** – Tirupati, (Andhra Pradesh)
  - ✓ Dedicated to Lord Venkateswara; founded by King Thondaiman, expanded by Cholas.
  - ✓ One of the richest and most visited temples in the world.
  - ✓ Known for Dravidian gopuram towers, golden vimana, and Vaikhanasa Agama rituals.
- **Simhachalam (Varaha Lakshmi Narasimha)** – Visakhapatnam, (Andhra Pradesh)
  - ✓ Eastern Ganga king Narasingha Deva I (13th c.); consecrated by Bhanudeva I in 1268 AD.
  - ✓ Combines Varaha (boar) and Narasimha (lion-man) avatars of Vishnu in a composite murti.
- **Suryanarayana (Arasavalli Sun Temple)** – Srikakulam, (Andhra Pradesh)
  - ✓ Built by Devendra Sarma in the 7th c. AD.
  - ✓ Noted for its east-facing sanctum designed to receive the first rays of the sun on equinox mornings.
- **Sri Bramarambha Mallikarjuna** – Srisailam (Andhra Pradesh)
  - ✓ Origin in Satavahana period; later additions by Vijayanagara's Harihara.
  - ✓ One of the 12 Jyotirlingas and one of the Shakti Peethas, unique as both Shiva and Shakti are worshipped together.
- **Sri Ranganathaswami** – Nellore
  - ✓ 12th c. riverside shrine to Lord Ranganatha.
  - ✓ Associated with Sri Vaishnava saints like Ramanuja and Annamacharya.
- **Veerabhadra** – Lepakshi (Andhra Pradesh)
  - ✓ Constructed 1530 AD under Vijayanagara rulers.
  - ✓ A fusion of Dravida and Vijayanagara architectural idioms.
  - ✓ Famous for its hanging pillar, ceiling frescoes & massive Nandi sculpture.
- **Kamakhya** – Guwahati (Assam)
  - ✓ Evolved between 8th–17th c.; pre-eminence in Shakti worship.
  - ✓ One of the 51 Shakti Peethas; a yoni-shaped sanctum symbolizes fertility and divine feminine power.
  - ✓ Important for Tantric traditions and Ambubachi Mela.
- **Dwarkadhish** – Dwarka (Gujarat)
  - ✓ A key Char Dham site for Lord Krishna.
  - ✓ Ancient submerged city believed to have been founded by Krishna himself.
  - ✓ Present temple is attributed to Vajranabha, Krishna's grandson.
- **Modhera Sun Temple** – Mehsana (Gujarat)
  - ✓ Commissioned by Chalukya king Bhima I in 1026–27 AD.
  - ✓ Sanctum designed so that sunlight falls directly on the idol at equinox.
  - ✓ Features a Surya Kund (stepped tank) and narrative friezes of Ramayana and Mahabharata.
- **Virupaksha** – Hampi (Karnataka)
  - ✓ Nayaka construction under Deva Raya II (15th c.).
  - ✓ Continuously functioning temple even after Vijayanagara's fall.
  - ✓ Dedicated to Shiva as Virupaksha, consort of local goddess Pampa.
- **Vittala** – Hampi (Karnataka)
  - ✓ Built by Deva Raya II (1422–46) & enhanced by Krishnadevaraya (1509–29).
  - ✓ Exhibits Provida/Vijayanagara style with elaborate mandapas.
  - ✓ Famous for its stone chariot and musical pillars producing different tones.

- 
- **Padmanabhaswamy** – Thiruvananthapuram (Kerala)
    - ✓ 8th c. origins; present granite structure under Marthanda Varma (18th c.).
    - ✓ Deity is reclining Vishnu on serpent Ananta, facing east.
    - ✓ One of the richest temples globally with ancient underground vaults.
  - **Sabarimala** – Periyar Tiger Reserve (Kerala)
    - ✓ Pre-12th c. shrine of Lord Ayyappa, nestled among 18 hills.
    - ✓ Famed for strict vratham (austerity) period, followed by arduous pilgrimage.
    - ✓ Makara Jyoti sighting and 18 sacred steps are central to the ritual.
  - **Omkareshwar** – Mandhata Island, Narmada (Madhya Pradesh)
    - ✓ One of the twelve Jyotirlingas on the river Narmada.
    - ✓ Island shaped like the Om symbol.
    - ✓ Architecture blends Malwa and Nagara features.
  - **Mahakaleshwar** – Ujjain (Madhya Pradesh)
    - ✓ River-bank Jyotirlinga dedicated to Shiva.
    - ✓ Only Dakshinamukhi (south-facing) Jyotirlinga.
    - ✓ Hosts Bhasma Aarti with sacred ash ritual held at dawn daily.
  - **Vitthal Rukmini (Vithoba)** – Pandharpur (Maharashtra)
    - ✓ 13th c. Hoysala foundation for Vishnu's form Vitthal and consort Rakhumai.
    - ✓ Pilgrimage center for Varkari movement; connected to saints like Tukaram and Dnyaneshwar.
    - ✓ Devotion marked by foot pilgrimages (Vari Yatra).
  - **Trimbakeshwar** – Nashik (Maharashtra)
    - ✓ Jyotirlinga sited among Brahmagiri, Nilagiri, Kalagiri hills; rebuilt by Peshwa Balaji Baji Rao.
    - ✓ Origin of the Godavari River. Lingam features three faces: Brahma, Vishnu, Shiva
  - **Konark Sun Temple** – Odisha
    - ✓ Eastern Ganga dynasty, 13th c.; chariot-form shrine to the sun god.
    - ✓ Depicts the Sun's chariot with 12 pairs of wheels, pulled by horses.
    - ✓ Carvings include astrological motifs, dancers, musicians, and erotic scenes.
  - **Lingaraja** – Bhubaneswar (Odisha)
    - ✓ 11th c. Somavamsi construction blending Shaiva-Vaishnava iconography.
    - ✓ Marks the culmination of Kalinga architecture.
  - **Thousand Pillar Temple** – Warangal (Telangana)
    - ✓ Kakatiya dynasty (12th–14th c.); shrines to Vishnu, Shiva, Surya.
    - ✓ Built in trikuta (triple shrine) layout.
    - ✓ Features star-shaped sanctums and richly carved Nandi pavilion.
  - **Ramappa Temple** – Palampet (Telangana)
    - ✓ 11th c. Kakatiya era; noted for floating bricks and ornate pillars.
    - ✓ Roof built using light-weight porous bricks (said to float on water).
    - ✓ Recently declared a UNESCO World Heritage Site.
  - **Ranganathaswamy** – Srirangam (Tamil Nadu)
    - ✓ Island temple of Lord Vishnu between Kaveri and Kollidam rivers.
    - ✓ Largest functioning Hindu temple complex in the world.
  - **Chandravalli cave complex-** (Karnataka )
    - ✓ Chambers include a place of worship with a Shiva linga.
    - ✓ It is also known as Ankali Math.
  - **Unakoti Cave Temples** – Tripura
    - ✓ 6th–7th c. rock reliefs; dubbed “Angkor Wat of the North-East.”
    - ✓ Features giant rock carvings of Shiva, Ganesha, and other deities.
-